



BASIC MANUAL

HF/50 MHz TRANSCEIVER
IC-7610



Thank you for choosing this Icom product. The IC-7610 HF/50 MHz TRANSCEIVER is designed and built with Icom's state of the art technology and craftsmanship. With proper care, this product should provide you with years of trouble-free operation. We appreciate you making the IC-7610 your transceiver of choice, and hope you agree with Icom's philosophy of "technology first." Many hours of research and development went into the design of your IC-7610.

IMPORTANT

READ ALL INSTRUCTIONS carefully completely before using the transceiver.

SAVE THIS INSTRUCTION MANUAL— This instruction manual contains basic operating instructions for the IC-7610. For the advanced operating instructions, see the Advanced Manual on the supplied CD.

FEATURES

- **RF Direct Sampling System**

The IC-7610 employs an RF direct sampling system. RF signals are directly converted to digital data and processed in the FPGA. This system is a leading technology marking an epoch in amateur radio.

- **2 identical receivers**

The IC-7610 has 2 independent receiver circuits for the Main and Sub bands.

- **A built-in DIGI-SEL unit**

Both the Main and Sub receivers have built-in DIGI-SEL (digital preselector) units. These reject interfering signals.

- **Real-Time Spectrum Scope**

Displays the Main and Sub band conditions. It provides class-leading performance in resolution, sweep speed and provides a 100 dB dynamic range.

- **A built-in automatic antenna tuner**

- **Multi-function control for easy settings**

- **Extra large 7 inch touch screen color display**

- **External monitor connection with a DVI-D port**

- **BNC type RX IN/OUT connectors**

- **Class Leading RMDR and Phase Noise Characteristics**

- **IP remote control capability with the optional RS-BA1 IP REMOTE CONTROL SOFTWARE**

- **Remote encoder capability with the optional RC-28 REMOTE ENCODER**

- **Dualwatch operation**

Icom is not responsible for the destruction, damage to, or performance of any Icom or non-Icom equipment, if the malfunction is because of:

- Force majeure, including, but not limited to, fires, earthquakes, storms, floods, lightning, or other natural disasters, disturbances, riots, war, or radioactive contamination.
- The use of Icom transceivers with any equipment that is not manufactured or approved by Icom.

SUPPLIED ACCESSORIES

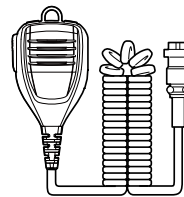

Hand microphone
(HM-219)

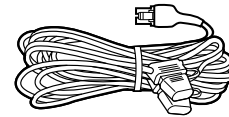

DC power cable
(3 m: 9.8 ft)



CW key plug
(6.35 mm: 1/4" Stereo)



CD

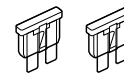

Spare fuse
(30 A)



Spare fuse
(5 A)

① Different types of accessories may be supplied, or may not be supplied depending on the transceiver version.

This product includes RTOS "RTX" software, and is licensed according to the software license.

This product includes "zlib" open source software, and is licensed according to the open source software license.

This product includes "libpng" open source software, and is licensed according to the open source software license.

Refer to the Text files in the License folder of included CD for information on the open source software being used by this product.

FCC INFORMATION

This equipment has been tested and found to comply with the limits for a Class B digital device, pursuant to part 15 of the FCC Rules. These limits are designed to provide reasonable protection against harmful interference in a residential installation. This equipment generates, uses and can radiate radio frequency energy and, if not installed and used in accordance with the instructions, may cause harmful interference to radio communications. However, there is no guarantee that interference will not occur in a particular installation. If this equipment does cause harmful interference to radio or television reception, which can be determined by turning the equipment off and on, the user is encouraged to try to correct the interference by one or more of the following measures:

- Reorient or relocate the receiving antenna.
- Increase the separation between the equipment and receiver.
- Connect the equipment into an outlet on a circuit different from that to which the receiver is connected.
- Consult the dealer or an experienced radio/TV technician for help.

WARNING: MODIFICATION OF THIS DEVICE TO RECEIVE CELLULAR RADIOTELEPHONE SERVICE SIGNALS IS PROHIBITED UNDER FCC RULES AND FEDERAL LAW.

CAUTION: Changes or modifications to this device, not expressly approved by Icom Inc., could void your authority to operate this device under FCC regulations.

ABOUT CE AND DOC

 Hereby, Icom Inc. declares that the versions of IC-7610 which have the "CE" symbol on the product, comply with the essential requirements of the Radio Equipment Directive, 2014/53/EU, and the restriction of the use of certain hazardous substances in electrical and electronic equipment Directive, 2011/65/EU. The full text of the EU declaration of conformity is available at the following internet address:
<http://www.icom.co.jp/world/support>

TRADEMARKS



Icom, Icom Inc. and the Icom logo are registered trademarks of Icom Incorporated (Japan) in Japan, the United States, the United Kingdom, Germany, France, Spain, Russia, Australia, New Zealand and/or other countries.

Microsoft, Windows and Windows Vista are registered trademarks of Microsoft Corporation in the United States and/or other countries.

Adobe, Acrobat, and Reader are either registered trademarks or trademarks of Adobe Systems Incorporated in the United States and/or other countries.

All other products or brands are registered trademarks or trademarks of their respective holders.

EXPLICIT DEFINITIONS

WORD	DEFINITION
 DANGER!	Personal death, serious injury or an explosion may occur.
 WARNING!	Personal injury, fire hazard or electric shock may occur.
CAUTION	Equipment damage may occur.
NOTE	Recommended for optimum use. No risk of personal injury, fire or electric shock.

ABOUT SPURIOUS SIGNALS

Spurious signals may be received near the following frequencies. These are made in the internal circuit and does not indicate a transceiver malfunction:

- 28.671 MHz
- 50.516 MHz
- 51.881 MHz
- 53.246 MHz
- 53.760 MHz

DISPOSAL



The crossed-out wheeled-bin symbol on your product, literature, or packaging reminds you that in the European Union, all electrical and electronic products, batteries, and accumulators (rechargeable batteries) must be taken to designated collection locations at the end of their working life. Do not dispose of these products as unsorted municipal waste. Dispose of them according to the laws in your area.

ABOUT THE TOUCH SCREEN

◇ Touch operation

In the Full manual or Basic manual, the touch operation is described as shown below.



Touch

If the display is touched briefly, one short beep sounds.



Touch for 1 second

If the display is touched for 1 second, one short and one long beep sound.

◇ Touch screen precautions

- The touch screen may not properly work when the LCD protection film or sheet is attached.
- Touching the screen with your finger nails, sharp topped object and so on, or touching the screen hard may damage it.
- Tablet PC's operations such as flick, pinch in and pinch out cannot be performed on this touch screen.

◇ Touch screen maintenance

- If the touch screen becomes dusty or dirty, wipe it clean with a soft, dry cloth.
- When you wipe the touch screen, be careful not to push it too hard or scratch it with your finger nails. Otherwise you may damage the screen.

ABOUT THE SUPPLIED CD

The following items are included on the CD.

- **Basic manual (English)**
Instructions for basic operations, the same as this manual.
- **Advanced manual (English)**
Instructions for advanced operations in English.
- **Basic manual (Multi-language)**
Instructions for basic operations in multiple languages.
- **Schematic diagram**
Includes the schematic and block diagrams.
- **HAM radio Terms (English)**
A glossary of HAM radio terms in English.
- **Adobe® Acrobat® Reader® Installer**
Installer for Adobe® Acrobat® Reader®.

To read the manuals or Schematic diagram, Adobe® Acrobat® Reader® is required. If you have not installed it, please install the Adobe Acrobat Reader on the CD or download it from Adobe Systems Incorporated's website.

A PC with the following Operating System is required.

- Microsoft® Windows® 10
- Microsoft® Windows® 8.1
- Microsoft® Windows® 7

Starting the CD

1. Insert the CD into the CD drive.
2. Double click "Menu.exe" on the CD.
 - Depending on the PC setting, the menu screen shown below is automatically displayed.
3. Click the desired button to open the file.
① To close the Menu screen, click [Quit].

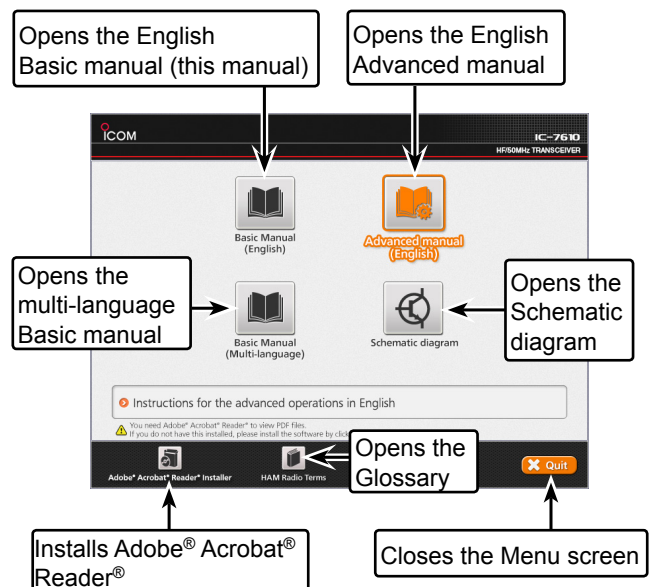

① Different types of menu screen may be displayed, depending on the transceiver version.

ABOUT THE CONSTRUCTION OF THE MANUAL

There are two different types of manuals for this transceiver, the Basic manual (this manual) and the Advanced manual.

◇ **Basic manual (This manual)**

Instructions for the basic operations, precautions, installations and connections.

◇ **Advanced manual (PDF type)**

Instructions for the advanced operations, such as listed below and more...

① The Advanced manual is on the CD that is supplied with the transceiver, or can be downloaded from the Icom website.

<http://www.icom.co.jp/world/support>

- User Band Edge
- IP Plus function
- Main/Sub Band Tracking function
- Adjusting the Drive Gain level
- VOX function
- ΔTX function
- Operating CW <Advanced>
- Operating RTTY (FSK) and PSK
- Data mode (AFSK) operation
- Scope operation <Advanced>
- Voice Recorder functions
- Voice TX Memory operation
- Using an SD card and USB flash drive <Advanced>
- Memory operation
- Scan
- Set mode <Advanced>
- Clock and Timers <Advanced>
- Updating the firmware
- Replacing fuse
- Cleaning

And more....

ABOUT THE INSTRUCTIONS

The Basic and Advanced manuals are described in the following manner.

“ ” (Quotation marks):

Used to indicate icons, setting items, and screen titles displayed on the screen.

The screen titles are also indicated in uppercase letters. (Example: FUNCTION screen)

[] (brackets):

Used to indicate keys.

Routes in the set modes and setting screens

Routes in the set mode, setting screen and the setting items are described in the following manner.

MENU » **SET > Time Set > Date/Time**

Instruction example

◇ Setting the current date

1. Open the DATE/TIME screen.

MENU » **SET > Time Set > Date/Time**

2. Touch “Date/Time.”
3. Touch “Date.”
 - Opens the date editing screen.

Detailed instruction

1. Push **MENU**.

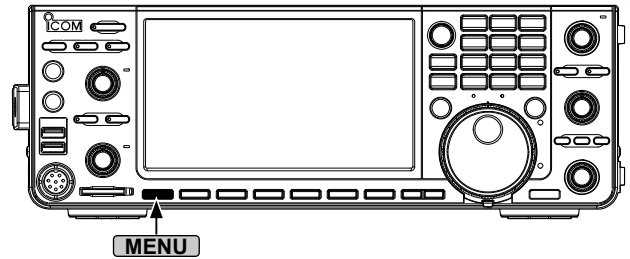

- Opens the MENU screen.

2. Touch **[SET]**.

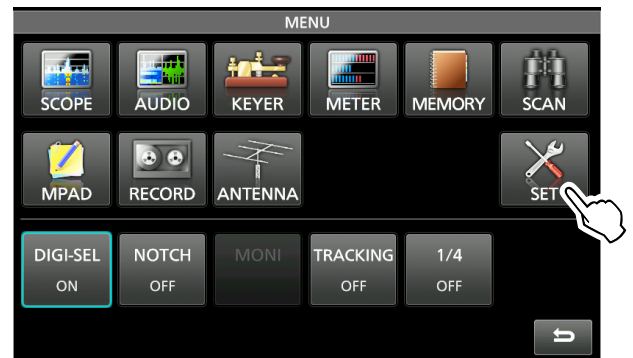

- Opens the SET screen.

3. Touch “Time Set.”
 - Opens the TIME SET screen.
4. Touch “Date/Time.”
 - Opens the DATE/TIME screen.
5. Touch “Date.”

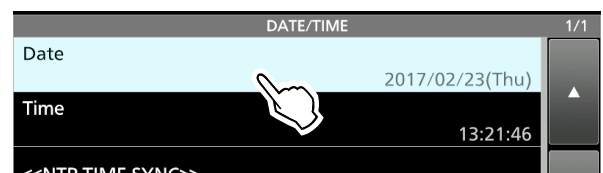

- Opens the date editing screen.

6. Touch **[+]** and **[-]** to set the date.

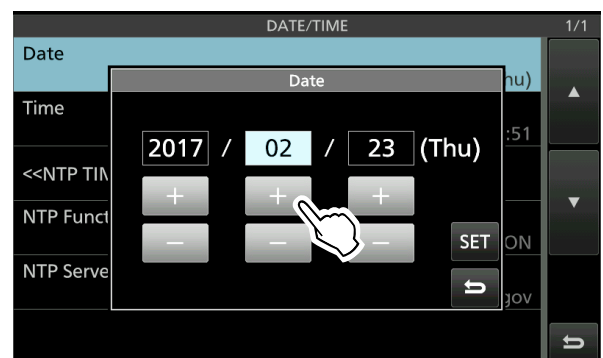

7. Touch **[SET]** to set the date.
 - ① Touch **[]** to cancel.
 - Returns to the previous screen.

TABLE OF CONTENTS

IMPORTANT.....	i	Setting the frequency	3-4
FEATURES.....	i	◇ Using the Main Dial	3-4
SUPPLIED ACCESSORIES	i	◇ Setting the Tuning Step function	3-4
FCC INFORMATION	ii	◇ Changing the Tuning Step.....	3-4
TRADEMARKS.....	ii	◇ Using the 1 Hz step Fine Tuning function ..	3-4
EXPLICIT DEFINITIONS.....	ii	◇ Using the 1/4 Tuning function.....	3-5
DISPOSAL.....	ii	◇ Using the Auto Tuning Step function	3-5
ABOUT CE AND DOC.....	ii	◇ Directly entering a frequency	3-5
ABOUT THE TOUCH SCREEN	iii	Dial Lock function	3-6
ABOUT THE SUPPLIED CD	iii	RF gain and SQL level	3-7
ABOUT THE CONSTRUCTION OF THE MANUAL ..iv		Meter display	3-7
ABOUT THE INSTRUCTIONS	v	◇ Selecting the Meter readout	3-7
PRECAUTIONS.....	viii	◇ About the Multi-function meter	3-7
		◇ Displaying the Multi-function meter	3-8
1. PANEL DESCRIPTION	1-1	Adjusting the transmit output power	3-8
Front panel	1-1	◇ Adjusting the transmit output power	3-8
Rear panel.....	1-3	Adjusting the microphone gain	3-9
Touch screen display.....	1-4	Basic transmission	3-9
◇ MENU screen	1-6		
◇ Multi-function menus	1-6	4. RECEIVING AND TRANSMITTING	4-1
◇ Multi-function key group	1-7	Preamplifiers	4-1
◇ QUICK MENU	1-7	Attenuator.....	4-1
Keyboard entering and editing	1-8	RIT function	4-1
◇ Keyboard types	1-8	◇ Using the RIT Monitor function.....	4-1
◇ Entering and editing	1-8	AGC function control	4-2
◇ Entering and editing example.....	1-9	◇ Selecting the AGC time constant	
		preset value	4-2
2. INSTALLATION AND CONNECTIONS	2-1	◇ Setting the AGC time constant	4-2
Using the desktop stands	2-1	Using the Twin PBT	4-3
Selecting a location	2-1	Selecting the IF filter.....	4-4
Heat dissipation.....	2-1	Selecting the IF filter shape.....	4-4
Grounding.....	2-1	Noise Blanker	4-5
Connecting an external DC power supply	2-1	◇ Adjusting the NB level and time	4-5
Connecting the antenna tuner	2-2	Noise Reduction	4-5
Connecting a Transverter	2-2	◇ Adjusting the Noise Reduction level.....	4-5
Linear amplifier connections.....	2-3	Digital Selector	4-6
◇ Connecting the IC-PW1/IC-PW1EURO	2-3	◇ Turning ON the Digital Selector function	4-6
◇ Connecting a non-Icom linear amplifier.....	2-3	◇ Adjusting the center frequency.....	4-6
3. BASIC OPERATION	3-1	Notch Filter	4-6
When first applying power	3-1	◇ Selecting the Notch function type.....	4-6
Turning power ON or OFF	3-1	◇ Auto Notch function	4-6
Adjusting the volume level.....	3-1	◇ Manual Notch function	4-7
Selecting the VFO and Memory modes	3-1	Monitor function.....	4-7
Selecting the Main and Sub bands.....	3-2	Speech Compressor (SSB).....	4-8
◇ Switching the Main band and Sub band.....	3-2	Auto Tuning function (AM/CW).....	4-8
Dualwatch operation.....	3-2	Split frequency operation.....	4-9
◇ Using the Dualwatch operation	3-2	◇ Using the Quick Split function	4-9
Selecting the operating band.....	3-3	◇ Using the receive and transmit frequencies	
◇ Selecting the operating band		set to Main and Sub	4-9
on the keypad.....	3-3	Split Lock function	4-10
◇ Selecting the operating band		Setting the transmit filter width	4-10
on the screen	3-3		
Selecting the operating mode.....	3-3		

TABLE OF CONTENTS (Continued)

Operating CW.....	4-10	9. CLOCK AND TIMERS	9-1
◇ Setting the CW pitch control.....	4-10	Setting the date and time	9-1
◇ Setting the keying speed	4-11	◇ Setting the date	9-1
◇ Using the Break-in function	4-11	◇ Setting the current time	9-1
◇ Monitoring the CW side tone.....	4-12	◇ Setting the UTC offset	9-1
◇ APF (Audio Peak Filter) operation	4-12	◇ Displaying CLOCK2	9-1
◇ About the Electronic Keyer function	4-13	◇ Setting the CLOCK2 UTC offset.....	9-2
5. SCOPE OPERATION.....	5-1	◇ Editing the CLOCK2 name	9-2
Spectrum scope screen.....	5-1	10. MAINTENANCE.....	10-1
◇ Marker	5-1	Resetting	10-1
◇ Using the Spectrum Scope	5-1	◇ Partial reset	10-1
◇ Displaying the Mini scope screen.....	5-2	◇ All reset	10-1
Audio scope screen.....	5-2	Troubleshooting.....	10-2
◇ Using the Audio scope	5-2	11. SPECIFICATIONS	11-1
◇ AUDIO SCOPE SET screen.....	5-3	◇ General	11-1
6. SD CARD/USB FLASH DRIVE	6-1	◇ Transmitter	11-1
About the SD cards	6-1	◇ Receiver	11-2
About the USB flash drive	6-1	◇ Antenna tuner.....	11-2
Saving data	6-1	12. OPTIONS	12-1
Inserting.....	6-1	13. CONNECTOR INFORMATION	13-1
Formatting	6-2	Interface information.....	13-1
◇ Formatting the SD card or		ACC sockets.....	13-2
USB flash drive.....	6-2	PHONES	13-3
Unmounting.....	6-2	ELEC-KEY.....	13-3
7. ANTENNA TUNER OPERATION	7-1	KEY	13-3
About the Antenna memory settings	7-1	DC 13.8 V.....	13-3
◇ The Antenna memory screen	7-1	TUNER	13-3
◇ Saving an antenna connector setting.....	7-1	MIC.....	13-3
◇ Selecting the antenna type.....	7-2	EXT KEYPAD	13-4
About the internal antenna tuner.....	7-2	REMOTE	13-4
Using the Internal antenna tuner.....	7-3	METER.....	13-4
◇ Manual tuning.....	7-3	USB port (type A)	13-4
◇ PTT Tuner start	7-3	ALC	13-4
About an external antenna tuner.....	7-3	SEND	13-4
◇ Using the AH-4 or AH-740	7-3	LAN	13-5
◇ Using an external antenna tuner	7-4	EXT-DISPLAY.....	13-5
Emergency mode (Tuner).....	7-4	USB 2	13-5
8. SET MODE.....	8-1	USB 1	13-5
Set mode description.....	8-1	EXT-SP A / EXT-SP B.....	13-5
◇ Entering the Set mode	8-1	REF IN.....	13-5
Tone Control/TBW	8-2	X-VERTER	13-6
Function.....	8-2	ANT 1 / ANT 2	13-6
Connectors	8-5	RX-ANT IN/OUT	13-6
Network	8-7	INSTALLATION NOTES	I
Display.....	8-8	INDEX.....	II
Time Set	8-9		
SD Card.....	8-9		
USB Flash Drive.....	8-10		
Others.....	8-10		

PRECAUTIONS

⚠ **DANGER HIGH RF VOLTAGE! NEVER** touch an antenna or antenna connector while transmitting. This could cause an electrical shock or burn.

⚠ **DANGER! NEVER** operate the transceiver near unshielded electrical blasting caps or in an explosive atmosphere. This could cause an explosion and death.

⚠ **WARNING RF EXPOSURE!** This device emits Radio Frequency (RF) energy. Extreme caution should be observed when operating this device. If you have any questions regarding RF exposure and safety standards please refer to the Federal Communications Commission Office of Engineering and Technology's report on Evaluating Compliance with FCC Guidelines for Human Radio Frequency Electromagnetic Fields (OET Bulletin 65).

⚠ **WARNING! NEVER** operate the transceiver with a headset or other audio accessories at high volume levels. If you experience a ringing in your ears, reduce the volume or discontinue use.

⚠ **WARNING! NEVER** apply AC power to the [DC13.8V] socket on the transceiver rear panel. This could cause a fire or damage the transceiver.

⚠ **WARNING! NEVER** apply more than 16 V DC to the [DC13.8V] socket on the transceiver rear panel. This could cause a fire or damage the transceiver.

⚠ **WARNING! NEVER** reverse the DC power cable polarity. This could cause a fire or damage the transceiver.

⚠ **WARNING! NEVER** remove the fuse holder on the DC power cable. Excessive current caused by a short could cause a fire or damage the transceiver.

⚠ **WARNING! NEVER** let metal, wire or other objects contact the inside of the transceiver, or make incorrect contact with connectors on the rear panel. This could cause an electric shock or damage the transceiver.

⚠ **WARNING! NEVER** operate or touch the transceiver with wet hands. This could cause an electric shock or damage to the transceiver.

⚠ **WARNING! NEVER** operate the equipment if you notice an abnormal odor, sound or smoke. Immediately turn OFF the power and/or remove the DC power cable. Contact your Icom dealer or distributor for advice.

⚠ **WARNING! NEVER** put the transceiver on an unstable place where the transceiver may suddenly move or fall. This could cause an injury or damage the transceiver.

⚠ **WARNING! NEVER** operate the transceiver during a lightning storm. It may result in an electric shock, cause a fire or damage the transceiver. Always disconnect the power source and antenna before a storm.

CAUTION: DO NOT expose the transceiver to rain, snow or any liquids. They could damage the transceiver.

CAUTION: DO NOT change the internal settings of the transceiver. This may reduce transceiver performance and/or damage the transceiver. The transceiver warranty does not cover any problems caused by unauthorized internal adjustments.

CAUTION: DO NOT install the equipment in a place without adequate ventilation, or block any cooling vents on the top, rear, sides or bottom of the transceiver or the cooling fan. Heat dissipation may be reduced and damage the transceiver.

CAUTION: DO NOT use harsh solvents such as benzene or alcohol when cleaning. This could damage the equipment surfaces. If the surface becomes dusty or dirty, wipe it clean with a soft, dry cloth.

CAUTION: DO NOT place or leave the transceiver in areas with temperatures below 0°C (32°F) or above 50°C (122°F).

CAUTION: DO NOT place the transceiver in excessively dusty environments, or in direct sunlight. This could damage the transceiver.

CAUTION: DO NOT set the transceiver's RF output power to more than a connected linear amplifier's maximum input level. Otherwise, the linear amplifier will be damaged.

CAUTION: DO NOT use non-Icom microphones. Other microphones have different pin assignments and may damage the transceiver.

BE CAREFUL! The transceiver will become hot when operating the transceiver continuously for long periods of time.

NEVER leave the transceiver in an insecure place to avoid use by unauthorized persons.

Turn OFF the transceiver's power and disconnect the DC power cable when you will not use the transceiver for long period of time.

The LCD display may have cosmetic imperfections that appear as small dark or light spots. This is not a malfunction or defect, but a normal characteristic of LCD displays.

Front panel

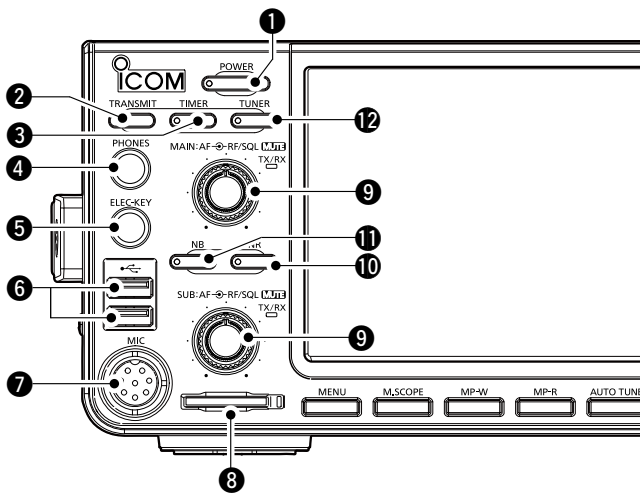

1 POWER KEY [POWER] (p. 3-1)
Turns the transceiver ON or OFF.

2 TRANSMIT KEY [TRANSMIT] (p. 3-9)
Toggles between transmit and receive.

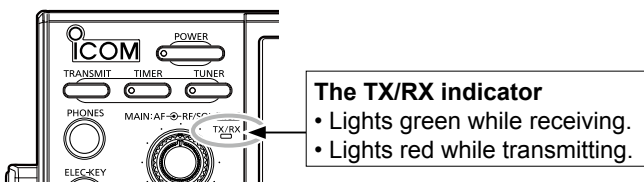

3 TIMER KEY [TIMER]
Turns the Sleep Timer or Daily Timer function ON or OFF.

4 HEADPHONE JACK [PHONES] (p. 13-3)
Connects to standard stereo headphones.

5 ELECTRONIC KEYS JACK [ELEC-KEY] (p. 13-3)
Connects to a paddle to use the internal electronic keyer for the CW operations.

6 USB PORT [USB A] (p. 13-4)
Insert a USB flash drive, USB A type keyboard, RC-28 REMOTE ENCODER, mouse or hub.

7 MICROPHONE CONNECTOR [MIC] (p. 13-3)
Connects to the supplied or an optional microphone.

8 SD CARD SLOT [SD CARD] (p. 6-1)
Accepts an SD card. The indicator next to the slot lights blue when inserted.

9 VOLUME CONTROL [AF→RF/SQL] (p. 3-1)

- ① The upper control is for the Main band, and the lower control is for the Sub band.
- Push to turn the Mute function ON or OFF.
 - The TX/RX indicator lights orange when the Mute function is ON.
- Adjusts the audio output level.

RF GAIN/SQUELCH CONTROL [AF→RF/SQL] (p. 3-7)
Adjusts the RF gain and squelch threshold levels.

10 NOISE REDUCTION KEY [NR] (p. 4-5)
Turns the Noise Reduction function ON or OFF.

11 NOISE BLANKER KEY [NB] (p. 4-5)
Turns the Noise Blanker ON or OFF.

12 ANTENNA TUNER KEY [TUNER] (p. 7-3)
Turns the antenna tuner ON or OFF, or activates the tuner.

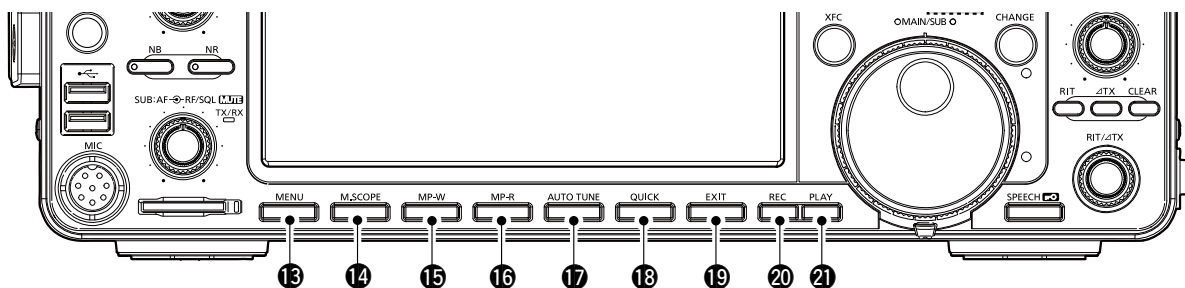

13 MENU KEY [MENU] (p. 8-1)
Displays the MENU screen.

14 MINI SCOPE KEY [M.SCOPE] (p. 5-2)
Displays the Mini Scope or Spectrum Scope.

15 MEMO PAD WRITE KEY [MP-W]
Saves the displayed contents into the Memo Pad.

16 MEMO PAD READ KEY [MP-R]
Sequentially calls up the contents in the Memo Pad.

17 AUTO TUNE KEY [AUTO TUNE] (p. 4-8)
Automatically tunes the operating frequency to a received CW signal.

18 QUICK KEY [QUICK] (p. 1-7)
Displays the QUICK MENU.

Front panel (Continued)

- 19 EXIT KEY** **EXIT**
Exits a setting screen or returns to the previous screen.
- 20 VOICE MEMORY RECORD KEY** **REC**
Saves the previously received signal for the preset time period set in REC Time, using the Instant Replay function, or starts recording a QSO audio onto an SD card.
- 21 VOICE MEMORY PLAY BACK KEY** **PLAY**
Plays back the last 5 seconds of the Instant Replay memory, or all of the Instant Replay memory.

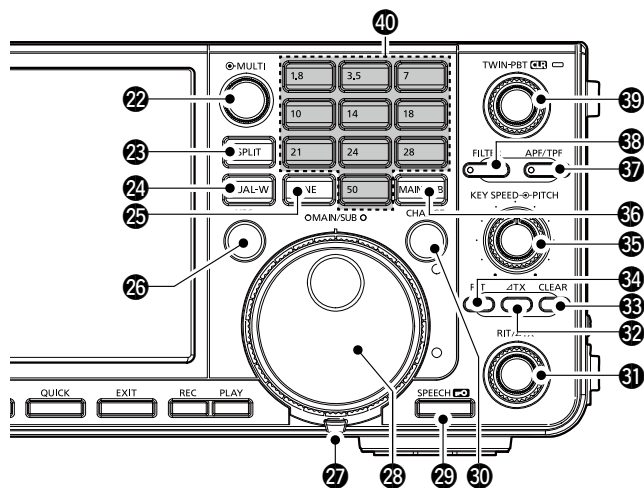

- 22 MULTI-FUNCTION CONTROL** **MULTI** (p. 1-6)
Displays the Multi-function menu for various adjustments, or selects an item.
- 23 SPLIT KEY** **SPLIT** (p. 4-9)
Turns the Split function ON or OFF.
- 24 DUALWATCH KEY** **DUAL-W** (p. 3-2)
Turns the Dualwatch function ON or OFF.
- 25 GENERAL COVERAGE BAND KEY** **GENE**
Selects the general coverage band.
- 26 TRANSMIT FREQUENCY CHECK KEY** **XFC** (p. 4-1, 4-9, 4-10)
Enables you to monitor the transmit frequency while holding it down in the Split mode.
- 27 TENSION ADJUSTER**
Adjusts the friction of **MAIN DIAL**.
- 28 MAIN DIAL** **MAIN DIAL** (p. 3-4)
Changes the operating frequency.

- 29 SPEECH/LOCK KEY** **SPEECH**
 - Announces the operating frequency and mode by pushing this key.
 - Electronically locks **MAIN DIAL** by holding down this key for 1 second.
- 30 MAIN/SUB CHANGE KEY** **CHANGE** (p. 3-2)
Toggles the frequency, mode and selected memory channel between the Main and Sub band.
- 31 RIT/ Δ TX CONTROL** **RIT/ Δ TX** (p. 4-1)
Shifts the receive or transmit frequency up to ± 9.99 kHz without changing the transmit or receive frequency.
- 32 Δ TX KEY** **Δ TX**
Turns the Δ TX function ON or OFF.
- 33 CLEAR KEY** **CLEAR**
Clears the RIT or Δ TX shift frequency.
- 34 RIT KEY** **RIT** (p. 4-1)
Turns the Receiver Incremental Tuning (RIT) function ON or OFF.
- 35 KEY SPEED** **KEY SPEED** **PITCH** CONTROL (p. 4-11)
Adjusts the internal electronic CW keyer speed.
- CW PITCH** **KEY SPEED** **PITCH** CONTROL (p. 4-10)
Shifts the received CW audio pitch and the CW side tone pitch without changing the operating frequency.
- 36 MAIN/SUB ACCESS KEY** **MAIN/SUB** (p. 3-2)
Selects the Main or Sub band frequency readout.
 - The selected band's frequency is displayed clearly whereas the non-selected band's frequency is displayed in gray.
- 37 AUDIO PEAK FILTER/ TWIN PEAK FILTER KEY** **APF/TPF** (p. 4-12)
In the CW mode, turns the Audio Peak Filter ON or OFF, and in the RTTY mode, turns the Twin Peak Filter ON or OFF.
- 38 FILTER KEY** **FILTER** (p. 4-4)
Selects one of three IF filters.
- 39 TWIN PASSBAND TUNING CONTROL** **TWIN PBT CLR** (p. 4-3)
Adjusts the IF filter's passband width.
- 40 KEYPAD** **1.8** ~ **50**
Selects the operating band by pushing once, or call up other stacked frequencies by pushing the same key several times.

1 PANEL DESCRIPTION

Rear panel

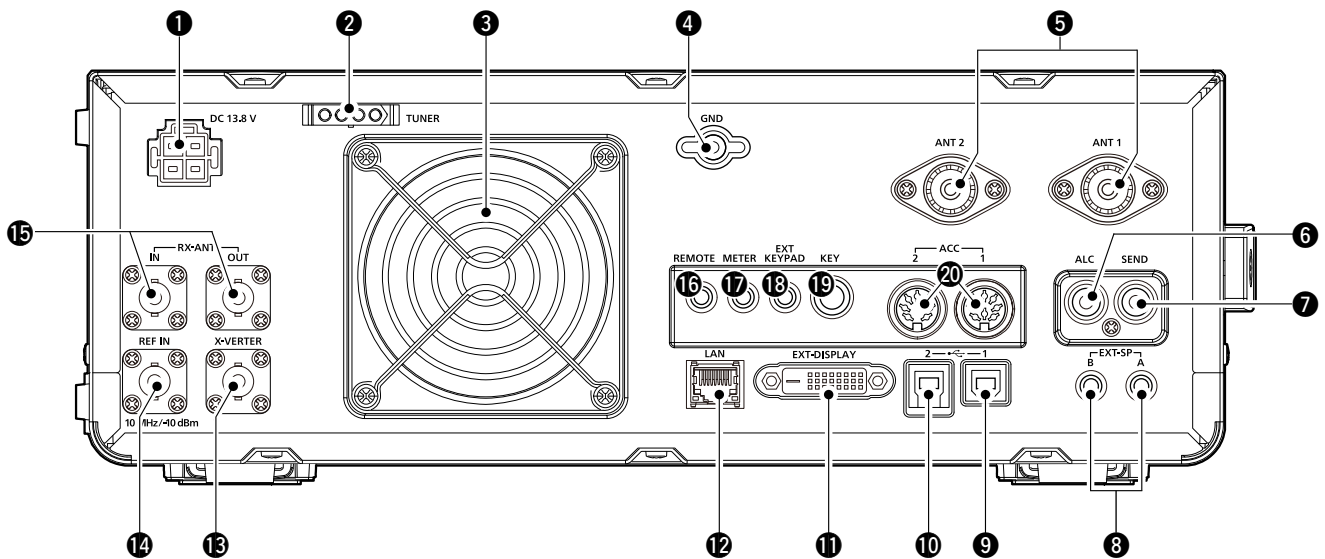

- 1 DC POWER SOCKET [DC 13.8 V]**
Connects to 13.8 V DC through the DC power cable.
- 2 TUNER CONTROL SOCKET [TUNER]**
Accepts the control cable from an optional AH-4 or AH-740 AUTOMATIC ANTENNA TUNER.
- 3 COOLING FAN**
Cools the PA unit when necessary.
- 4 GROUND TERMINAL [GND]**
Connects to ground to prevent electrical shocks, TVI, BCI and other problems.
- 5 ANTENNA CONNECTOR [ANT1]/[ANT2]**
Connects to a 50 Ω antenna. If you use the AH-4 or AH-740, you must connect the antenna to [ANT1].
- 6 ALC INPUT JACK [ALC]**
Connects to the ALC output jack of a non-Icom linear amplifier.
- 7 SEND CONTROL JACK [SEND]**
Connects to control transmit with non-Icom external units.
- 8 EXTERNAL SPEAKER JACK A/B [EXT-SP]**
Accepts a 4 ~ 8 Ω external speaker.
- 9 USB PORT [USB 1] (Type B)**
Connects to a PC for remote control operations.
- 10 USB PORT [USB 2] (Type B)**
For digital data input or output.
- 11 EXTERNAL DISPLAY CONNECTOR [EXT-DISPLAY]**
Connects to an external display monitor.
- 12 ETHERNET CONNECTOR [LAN]**
Connects to a PC network through a LAN.
- 13 TRANSVERTER CONNECTOR [X-VERTER]**
Connects to an external transverter for input/output.
- 14 REFERENCE SIGNAL INPUT [REF IN]**
Input for a 10 MHz reference signal through the BNC connector.
- 15 RECEIVE ANTENNA [RX ANT-IN]/[RX ANT-OUT]**
Connects to an external unit, such as preamplifier or RF filter, using BNC connectors.
 - This is located between the transmit/receive switching circuit and receiver's RF stage.
- 16 CI-V REMOTE CONTROL JACK [REMOTE]**
Connects to a PC or other transceiver for remote control.
- 17 METER JACK [METER]**
Outputs received signal strength, transmit output power, VSWR, ALC, speech compression, Vd or Id levels for an external meter.
- 18 EXTERNAL KEYPAD JACK [EXT KEYPAD] (p. 13-4)**
Connects to an external keypad for direct voice memory, memory keyer, RTTY memory or PSK memory transmission.
- 19 STRAIGHT KEY JACK [KEY]**
Connects to a straight key or external electronic keyer with 1/4 inch standard plug.
- 20 ACC SOCKET [ACC1]/[ACC2]**
Connects to devices to control an external unit or to control the transceiver.

Touch screen display

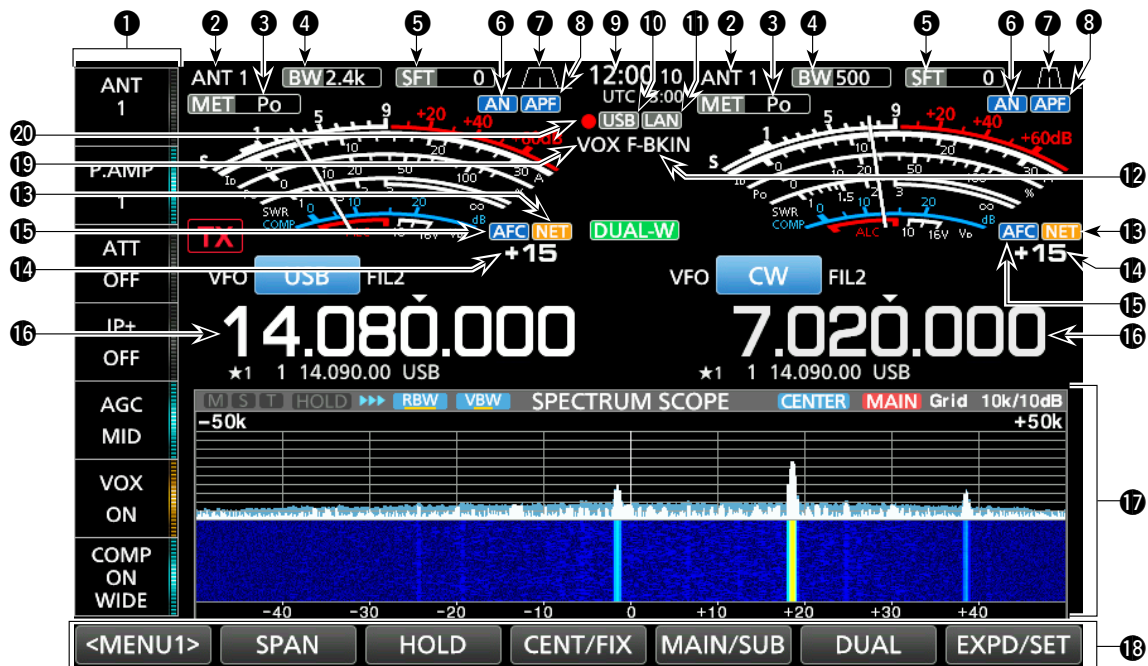

1 MULTI-FUNCTION KEY GROUP

Displays the Multi-function keys.

2 ANTENNA INDICATOR (p. 7-1)

Displays the selected antenna connector between ANT 1 and ANT 2.

3 METER TYPE INDICATOR (p. 3-7)

Displays the selected transmit parameter type. Select between Po, SWR, ALC, COMP, Vd and Id.

4 BANDWIDTH INDICATOR (p. 4-3, 4-4)

Displays the passband width of the IF filter.

5 SHIFT FREQUENCY INDICATOR (p. 4-3)

Displays the shift frequency of the IF filter.

6 NOTCH INDICATOR (p. 4-6)

“AN” is displayed when the Auto Notch function is ON, and “MN” is displayed when the Manual Notch function is ON.

7 PASSBAND WIDTH INDICATOR (p. 4-3)

Displays the passband width for twin PBT operation and the center frequency for IF shift operation.

8 AUDIO PEAK FILTER (APF) INDICATOR (p. 4-12)

Displayed when the Audio Peak Filter is ON.

9 CLOCK READOUT (p. 9-1)

Displays the time (2 types) set on the TIME SET screen.

10 USB INDICATOR (p. 6-1)

Displayed while a USB flashed drive is inserted.

11 LAN INDICATOR

Displayed while the transceiver and the optional RS-BA1 are connected through the LAN for remote control operation.

12 BK-IN/F-BKIN INDICATOR (p. 4-11)

Displayed while the Semi Break-in or Full Break-in function is ON.

13 NET FUNCTION INDICATOR (p. 8-7)

Displayed when the NET function is ON while in the PSK mode.

14 FREQUENCY OFFSET READOUT

Displays the offset value between the PSK signal and the operating frequency, while a PSK signal is received.

15 AFC FUNCTION INDICATOR

Displayed while the Automatic Frequency Control (AFC) function is ON, in the PSK mode.

16 FREQUENCY READOUT (p. 3-4)

Displays the operating frequency.
① The non-selected band's frequency readout (Main or Sub) is displayed in gray.

17 FUNCTION DISPLAY

Displayed when an item that has a function display is selected. For example, the Spectrum Scope.

18 FUNCTION KEYS (p. 5-1)

Displays the operating parameters, modes, frequencies and indicators, and so on.

19 VOX INDICATOR

Displayed while the VOX function is ON.

20 VOICE RECORDER ICON

- “●” is displayed while recording.
- “||” is displayed while pausing.

1 PANEL DESCRIPTION

Touch screen display (Continued)

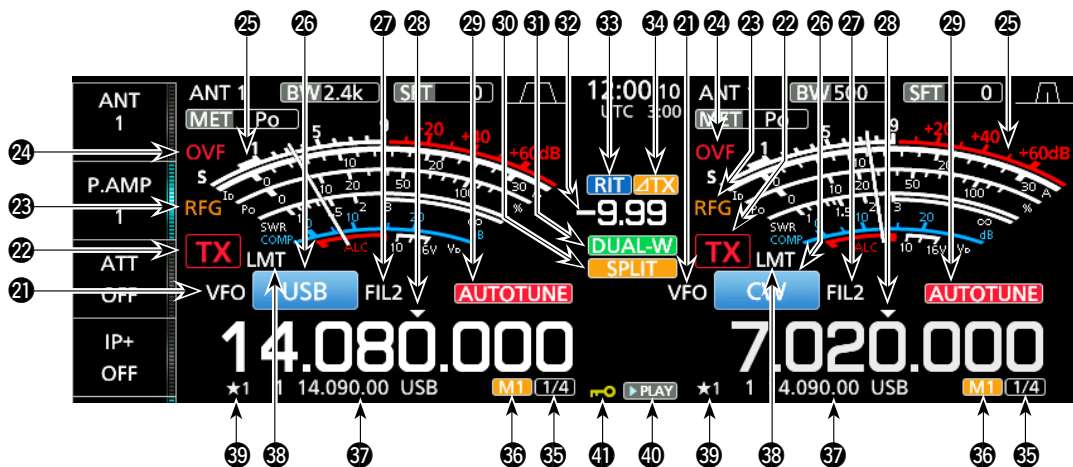

21 VFO/MEMORY ICON (p. 3-1)

“VFO” is displayed when the VFO mode is selected, and the memory number is displayed when a Memory channel is selected.

22 TX STATUS INDICATOR (p. 3-4, 3-9)

Displays the transmit status of the displayed frequency.

- **TX** is displayed while the displayed frequency is within the amateur band range.
- **TX** (Red background) is displayed while transmitting.
- **TX** (With a border of short dashes) is displayed when the selected frequency is outside of the amateur band frequency.
- **TX** (Grayed out) is displayed while the transmitter is inhibited.

23 RF GAIN INDICATOR (p. 3-7)

Displayed when (AF/RFS/SQL) (outer) is set counterclockwise from the 11 o'clock position. The indicator shows that the RF gain is reduced.

24 OVF ICON (p. 3-7)

“OVF” is displayed when an excessively strong signal is received.

25 METER INDICATOR (p. 3-7)

Displays the S, Id, Po, SWR, COMP, ALC and Vd meters.

26 MODE INDICATOR (p. 3-3)

Displays the selected operating mode.

27 IF FILTER INDICATOR (p. 4-3, 4-4)

Displays the selected IF filter.

28 QUICK TUNING ICON (p. 3-4)

Displayed when the quick Tuning Step function is ON.

29 AUTO TUNE INDICATOR (p. 4-8)

Displays “AUTOTUNE” when the Auto Tuning function is ON.

30 SPLIT ICON (p. 4-9)

Displayed when the Split function is ON.

31 DUALWATCH ICON (p. 3-2)

Displayed when using Dualwatch.

32 SHIFT FREQUENCY READOUT (p. 4-1)

Displays the shift offset for the RIT or ΔTX functions, while these functions are ON.

33 RIT ICON (p. 4-1)

Displayed when the RIT function is ON.

34 ΔTX ICON

Displayed when the ΔTX function is ON.

35 1/4 TUNING STEP INDICATOR (p. 3-5)

Displayed while the 1/4 Tuning Step function is ON.

36 M1~M8/T1~T8

- Displays “M1”~“M8” while using the Memory Keyer function is used.
- Displays “T1”~“T8” while using the Voice TX memory function.

37 MEMORY CHANNEL/VFO READOUT (p. 3-1)

Displays the selected memory channel contents in the VFO mode, and displays the VFO contents in the Memory mode.

38 LMT ICON

Displayed if the power amplifier temperature becomes extremely high and the protection function is activated after transmitting continuously for long periods of time.

39 SELECT MEMORY CHANNEL ICON

Indicates that the displayed memory channel is assigned as a Select memory channel (★1~★3).

40 PLAY ICON

Displayed while playing the recorded voice audio.

41 DIAL LOCK INDICATOR (p. 3-6)

Displayed while the Lock function is ON.

Touch screen display (Continued)

◇ MENU screen

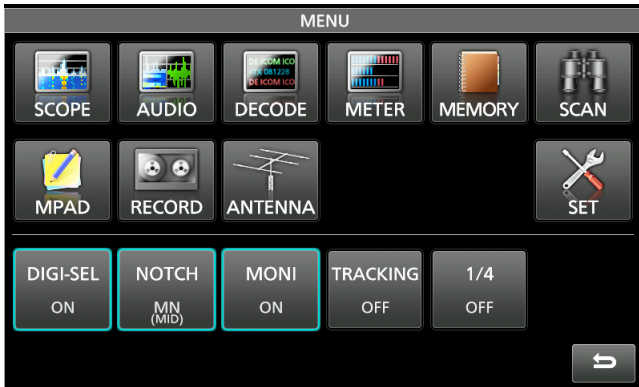

- Open the MENU screen by pushing **MENU**.

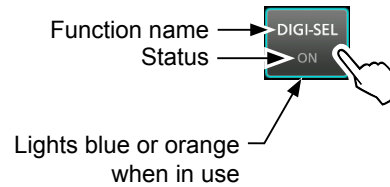

- ① The items displayed on the menu differ, depending on the selected operating mode.

◇ Multi-function menus

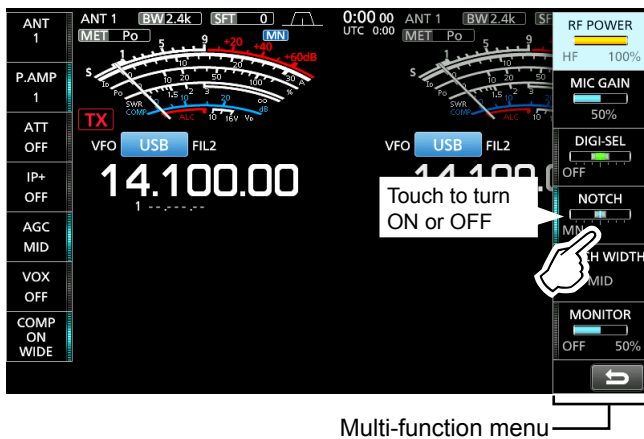

Multi-function menu

- Open the Multi-function menu by pushing **MULTI** (Multi-function control).
- While the Multi-function menu is open, touch the desired item and rotate **MULTI** to adjust the value.
- ① You can open other menus by holding down **NB** or **NR** for 1 second, or touching “ATT,” “VOX,” “BK-IN” or “COMP” in the Multi-function key group for 1 second.

Multi-function menu items

SSB	CW	RTTY	PSK
RF POWER	RF POWER	RF POWER	RF POWER
MIC GAIN	MIC GAIN	MIC GAIN	MIC GAIN
DIGI-SEL	DIGI-SEL	DIGI-SEL	DIGI-SEL
NOTCH	NOTCH	NOTCH	NOTCH
NOTCH WIDTH	NOTCH WIDTH	NOTCH WIDTH	NOTCH WIDTH
MONITOR		MONITOR	MONITOR
AM	FM	NB	NR
RF POWER	RF POWER	LEVEL	LEVEL
MIC GAIN	MIC GAIN	DEPTH	
DIGI-SEL	DIGI-SEL	WIDTH	
NOTCH	NOTCH		
NOTCH WIDTH			
MONITOR	MONITOR		
ATT	VOX	BK-IN	COMP
LEVEL	GAIN	DELAY	LEVEL
	ANTI VOX		TBW
	DELAY		
	VOICE DELAY		

1 PANEL DESCRIPTION

Touch screen display (Continued)

◇ Multi-function key group

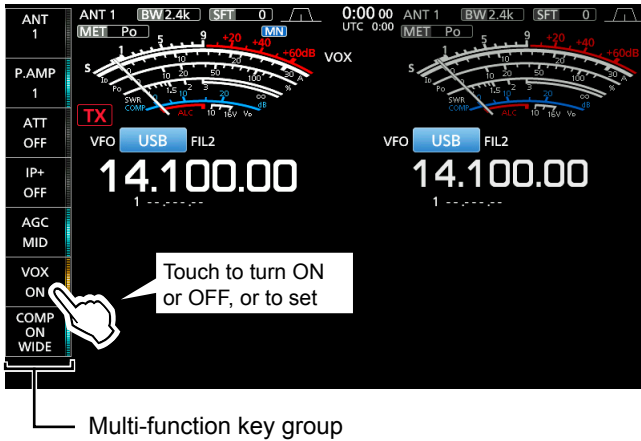

Multi-function key group items

	SSB	CW	RTTY	PSK	AM	FM
ANT	✓	✓	✓	✓	✓	✓
P.AMP	✓	✓	✓	✓	✓	✓
ATT	✓	✓	✓	✓	✓	✓
IP+	✓	✓	✓	✓	✓	✓
AGC	✓	✓	✓	✓	✓	✓
VOX	✓				✓	✓
BK-IN		✓				
COMP	✓					
TONE						✓

- Touch a key to turn the function ON or OFF.
 - Touching “ATT,” “VOX,” “BK-IN” or “COMP” for 1 second opens the ATT menu, VOX menu, BK-IN menu or COMP menu.
- ① See “Multi-function menus” on the previous page for details.

◇ QUICK MENU

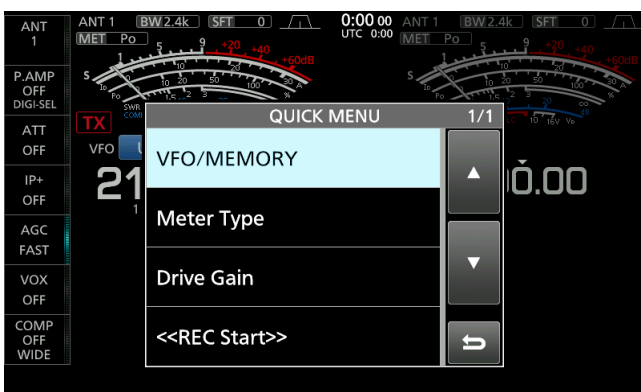

- Open the QUICK MENU by pushing **QUICK**.

Keyboard entering and editing

You can enter and edit the items on the following screens.

① Usable characters, symbols, and the amount of characters that can be entered differs, depending on the editing item.

- MY CALL
- FILE NAME
- NETWORK NAME
- NETWORK RADIO NAME
- NETWORK USER1 ID
- NETWORK USER2 ID
- NETWORK USER 1 PASSWORD
- NETWORK USER 2 PASSWORD
- NTP SERVER ADDRESS
- CLOCK2 NAME
- KEYSER MEMORY
- PSK MEMORY
- RTTY MEMORY
- VOICE TX RECORD (T1) ~ (T8)
- MEMORY NAME

◇ Keyboard types

You can select the Full Keyboard or Tenkey by pushing **QUICK** while displaying an entry mode screen.

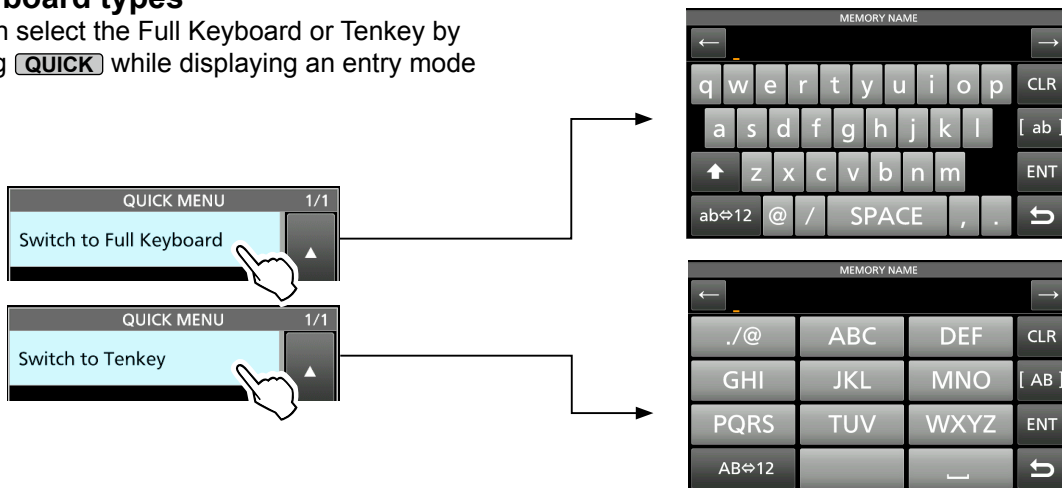

◇ Entering and editing

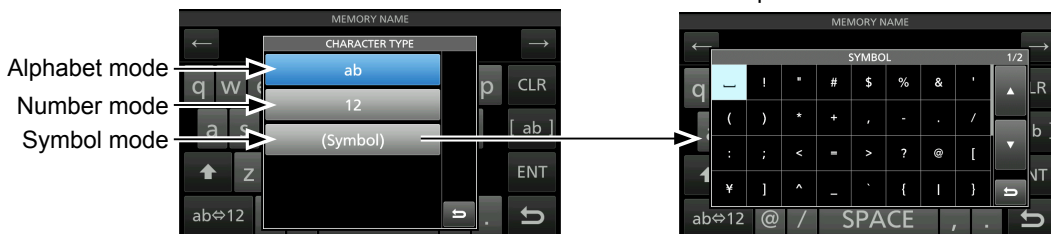
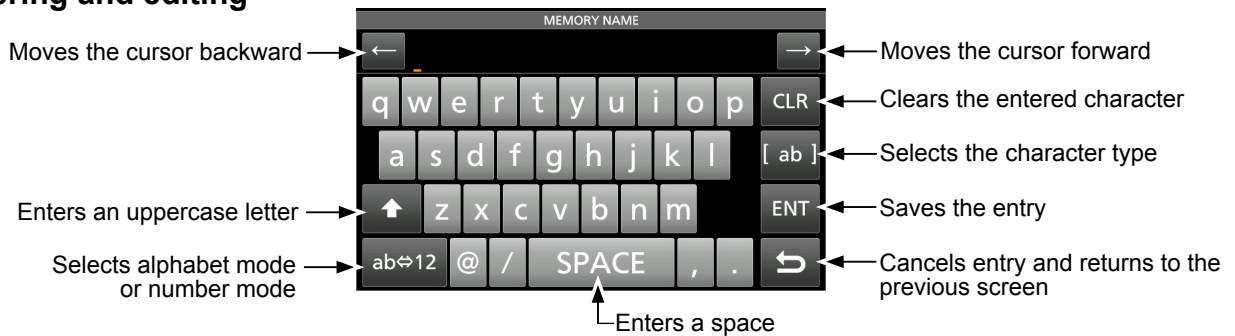

1 PANEL DESCRIPTION

Keypad entering and editing (Continued)

◇ Entering and editing example

Entering “DX spot 1” in the Memory channel 2

1. Display the MEMORY screen.



2. Touch the memory channel 2 for 1 second.
 - The MEMORY MENU screen is displayed.

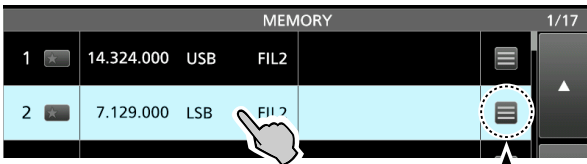

You can also display the MEMORY MENU screen by touching this key.

3. Touch “Edit Name.”
 - The MEMORY NAME screen is displayed.

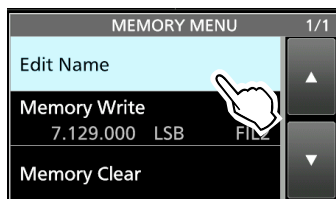

4. Touch [↑], and then touch [D].
 - ① Touching [↑] changes between uppercase and lowercase letter.

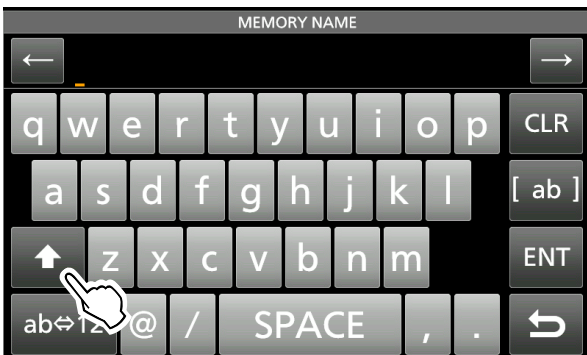

5. Touch [↑] again, and then touch [X].
6. Touch [SPACE] to enter a space.

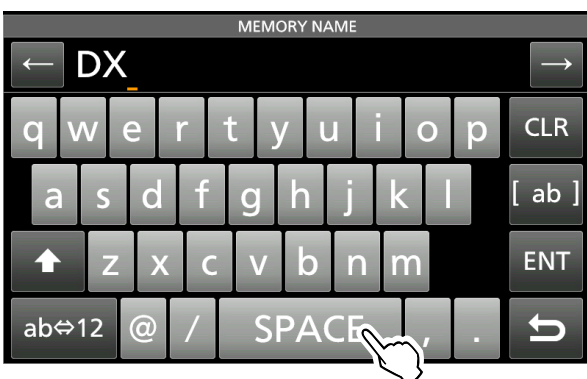

7. Touch [s], [p], [o], and then [t].
8. Touch [SPACE] to enter a space.
9. Touch [ab].
 - The CHARACTER TYPE screen is displayed.



10. Touch [12].

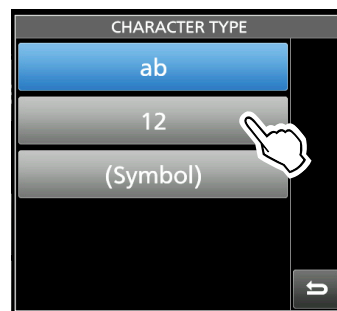

11. Touch [1].
12. Touch [ENT] to save the entry.

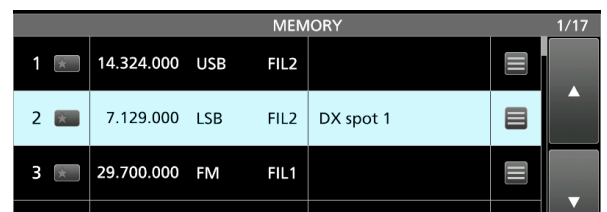
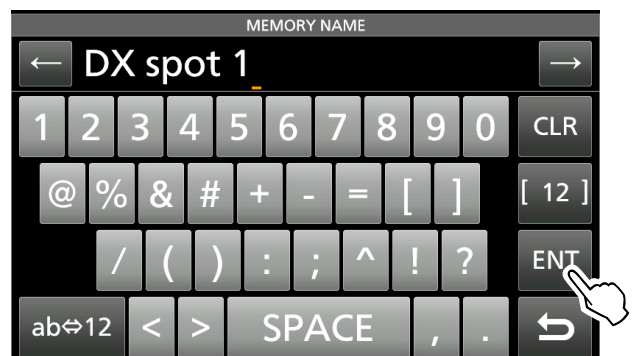

- Returns to the previous screen.

Using the desktop stands

The transceiver has legs for desktop use.

- Pull-out the legs on both sides until they lock in place.

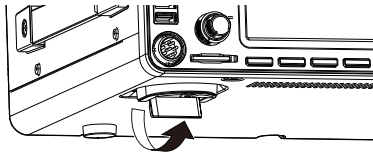

NOTE: DO NOT hold the stand, dials and controls when you carry the transceiver. This may damage them.

Selecting a location

Select a location for the transceiver that allows adequate air circulation, free from extreme heat, cold or vibrations, and other electromagnetic sources.

Never place the transceiver in areas such as:

- Temperatures below 0°C (+32°F) or above +50°C (+122°F).
- An unstable place that slopes or vibrates.
- In direct sunlight.
- High humidity and temperature environments.
- Dusty environments.
- Noisy environments.

Heat dissipation

- **NEVER** install the transceiver in a place without adequate ventilation. Heat dissipation may be reduced, and the transceiver may be damaged.
- **DO NOT** place the transceiver against walls or put anything on top of the transceiver. This may block airflow and overheat the transceiver.
- **DO NOT** touch the rear panel after transmitting continuously for long periods of time. The panel may become hot.

Grounding

To prevent electrical shock, television interference (TVI), broadcast interference (BCI) and other problems, ground the transceiver using the ground terminal [GND] on the rear panel.

For best results, connect a heavy gauge wire or strap to a long ground rod. Make the distance between the [GND] terminal and ground as short as possible.

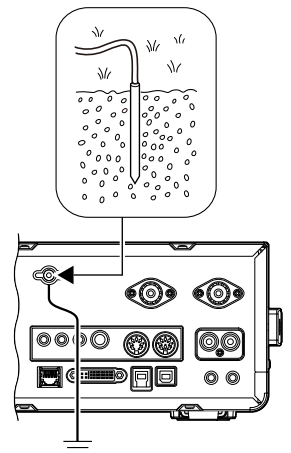

⚠ WARNING! NEVER connect the [GND] terminal to a gas or electric pipe, since the connection could cause an explosion or electric shock.

Connecting an external DC power supply

Be sure that the power supply power is OFF before connecting the DC power cable.

We recommend using Icom's optional PS-126 (13.8 V DC/25 A) power supply.

① When using a non-Icom DC power supply, you need:

- 13.8 V DC (Capacity: At least 23 A)
- A power supply with an over current protective line and low voltage fluctuation or ripple.

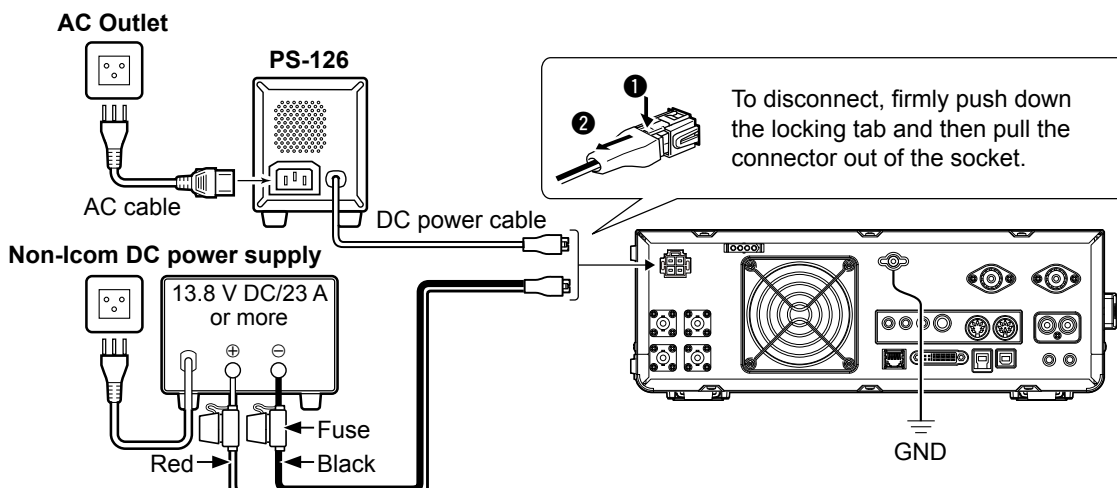

CAUTION: DO NOT touch the rear panel of the transceiver after transmitting continuously for long periods of time. It can become very hot.

Connecting the antenna tuner

The AH-4 matches the IC-7610 to the optional AH-2b or to a long wire antenna more than 7 m/23 ft long (usable between 3.5 and 50 MHz).

- ① See the AH-4 instruction manual for installation and connection details.
- ① See the Advanced Manual for connecting the optional AH-740 AUTOMATIC ANTENNA TUNER.

NOTE:

- Before connecting, be sure to turn OFF the transceiver.
- While the AH-4 is connected, the IC-7610's internal antenna tuner is deactivated.

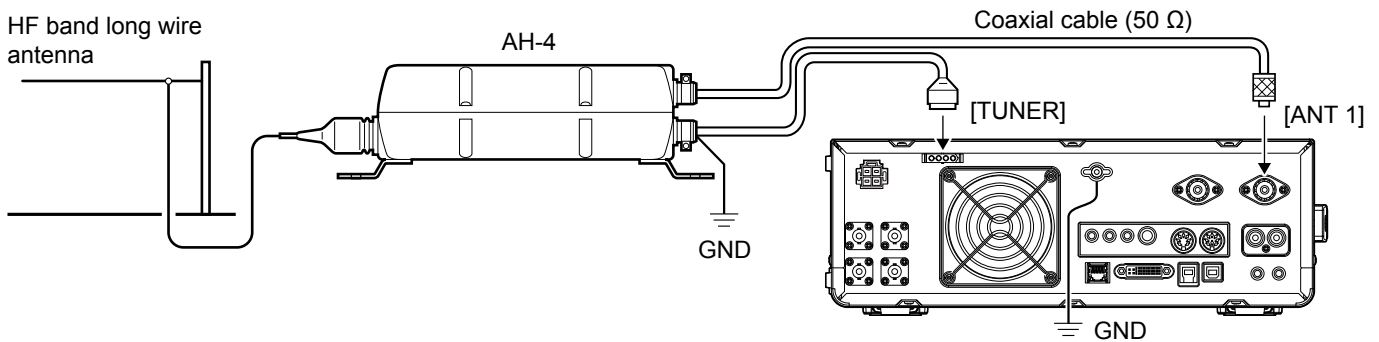

Connecting a Transverter

Connect your transverter unit as described below.

- ① You may need to connect to [ALC], depending on the transverter.

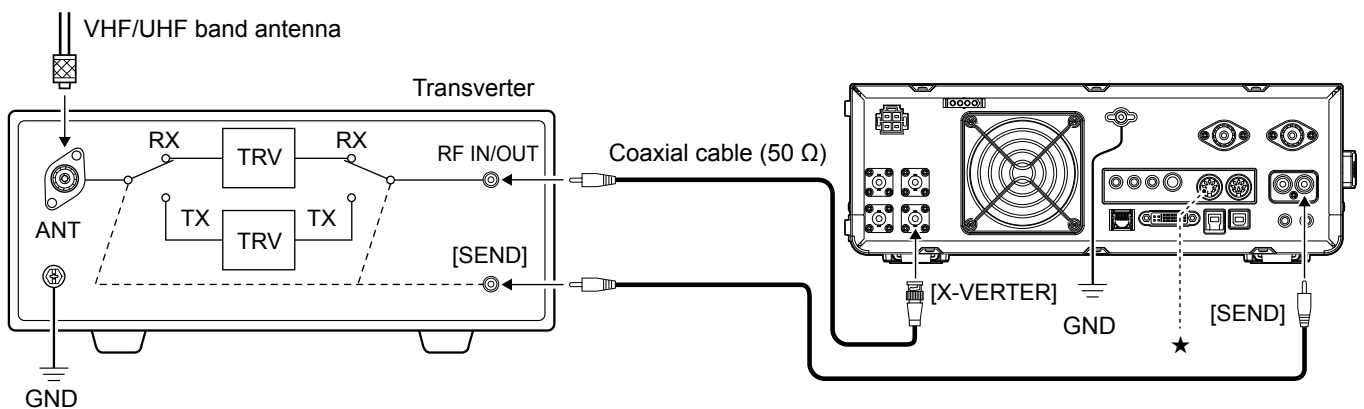

- Set the "Transverter Function" item to ON to use the transverter operating mode.
 - ★ You can also use the transverter operating mode by connecting a DC voltage to [ACC 2 (6: TRV)].
 - MENU** » **SET > Function > Transverter Function**
 - ① You cannot select the antenna or use the internal tuner while using the Transverter function.
- Set the offset frequency for the transverter operation.
 - MENU** » **SET > Function > Transverter Offset**

Linear amplifier connections

◇ Connecting the IC-PW1/IC-PW1EURO

See the illustration below to connect the optional IC-PW1 or IC-PW1EURO HF/50 MHz ALL BAND 1 kW LINEAR AMPLIFIER. Refer to the amplifier's instruction manual for operation.

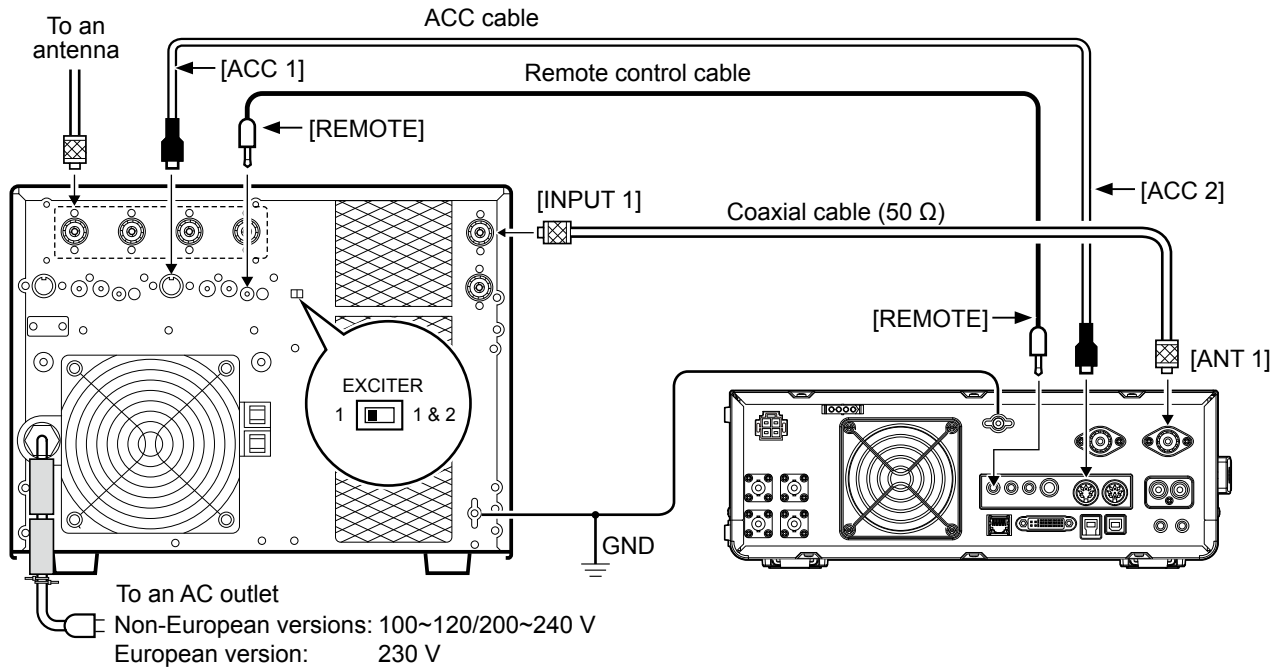

⚠ WARNING! When using a linear amplifier such as the IC-PW1 or IC-PW1EURO, set the RF POWER in the Multi-function menu to keep the ALC meter in the red zone.
 ① See page 3-8 for details on the RF POWER settings.
 ① See page 3-9 for details on the ALC zone settings.

◇ Connecting a non-Icom linear amplifier

See the illustration below to connect a non-Icom linear amplifier.

① We recommend that you use a linear amplifier with a specified input power of 100 watts or more. If you use an amplifier with a specified drive level of less than 100 watts, adjust the IC-7610's output power to the specified level before transmitting. Otherwise the linear amplifier may be damaged.

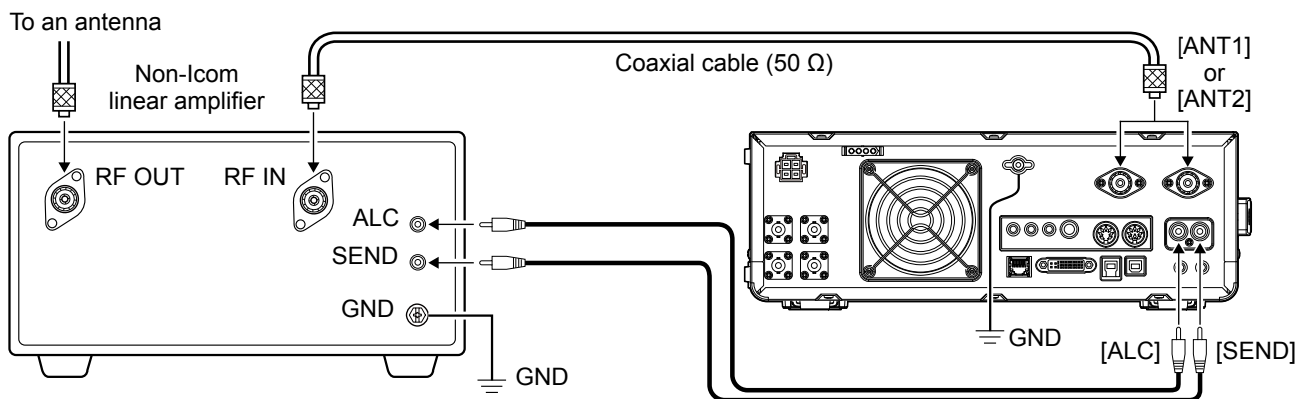

⚠ WARNING!

- The maximum signal level of the [SEND] jack is 16 V/0.5 A DC, and 250 V/200 mA with the "MOSFET" setting (p. 13-2). Use an external unit if your non-Icom linear amplifier requires a control voltage and/or current greater than specified.
- The ALC input level must be in the range 0 to -4 V. The transceiver does not accept a positive voltage. Non-matched ALC and RF power settings could overheat or damage the linear amplifier.

When first applying power

Before turning ON your transceiver for the first time, make sure all connections are correctly made.

After all connections are made, set the dials to the positions described below.

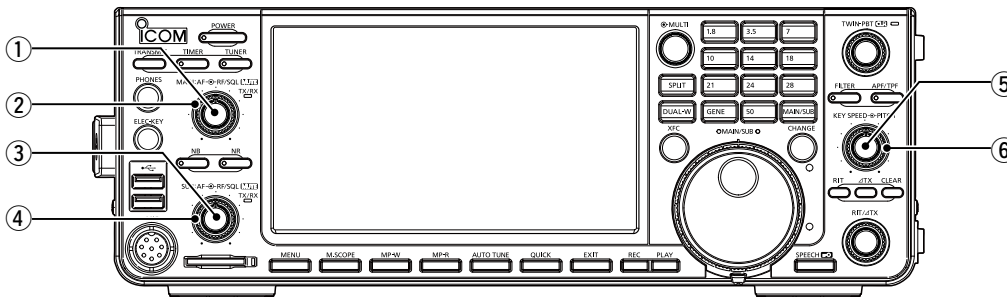

- ① MAIN **AF→RF/SQ** (inner): Fully counterclockwise
- ② MAIN **AF→RF/SQ** (outer): 12 o'clock
- ③ SUB **AF→RF/SQ** (inner): Fully counterclockwise
- ④ SUB **AF→RF/SQ** (outer): 12 o'clock

- ⑤ **KEY SPEED→PITCH** (inner): Fully counterclockwise
- ⑥ **KEY SPEED→PITCH** (outer): 12 o'clock

TIP: When you turn OFF the transceiver, it saves the current settings. Therefore, when you turn ON the transceiver again, it starts with the same settings.

Turning power ON or OFF

- To turn ON the transceiver, push **POWER**.
- To turn OFF the transceiver, hold down **POWER** for 2 seconds until “POWER OFF...” is displayed.

Adjusting the volume level

Rotate **AF→RF/SQ** (inner) to adjust the volume level.

Selecting the VFO and Memory modes

VFO mode

You can set a frequency by rotating **MAIN DIAL**.

- ① Using the VFO mode may be easier for the first initial operation.

Memory mode

You can recall a frequency that you have memorized on the MEMORY list.

Selecting the VFO mode or Memory mode

1. Push **QUICK**.
 - The QUICK MENU screen is displayed.
2. Touch “VFO/MEMORY.”

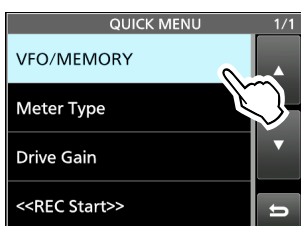

3. Touch [VFO] or [Memory] to select the mode.



VFO indicator

VFO mode screen



Memory channel number

Memory mode screen

4. Push **EXIT** to close the VFO/MEMORY screen.

Selecting the Main and Sub bands

The IC-7610 has 2 identical receivers, Main and Sub. The Main band is displayed on the left side of the screen, and the Sub band is displayed on the right side. Some functions can only be applied to the selected band, and you can transmit on only the Main band (except in Split Frequency operation).

To select the Main band or Sub band, touch the frequency readout.

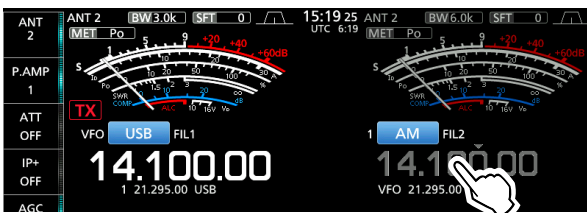

- The selected band's frequency readout is displayed clearly, and the frequency of the non-selected band is grayed.
- The selected band's indicator lights as described below.

Example: When the Sub band is selected, the MAIN/SUB indicator lights on the Sub band side.

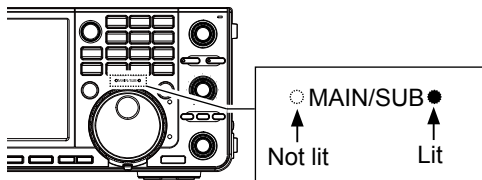

The Main band is selected.



The Sub band is selected.

NOTE: The Sub band readout is activated during Split operation or Dualwatch operation.

- See page 4-9 for details on Split operation.
- See the right column for details on Dualwatch operation.

① You can also push **MAIN/SUB** to select the Main band or Sub band.

◇ Switching the Main band and Sub band

You can switch the Main band and Sub band settings, such as the operating frequency, mode, and so on.

Push **CHANGE**.

- The Main and Sub band settings are switched.

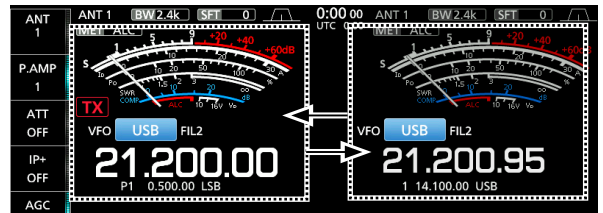

Dualwatch operation

Dualwatch simultaneously monitors two frequencies. The IC-7610 has 2 independent receiver circuits, the Main and Sub bands, so that you can use Dualwatch with no compromises, even on different bands and modes.

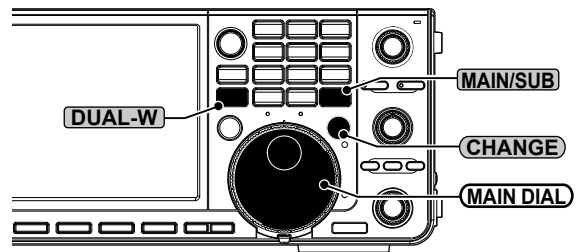

◇ Using the Dualwatch operation

1. Push **DUAL-W** briefly to start the Dualwatch operation.
 - "DUAL-W" is displayed.
 - ① To equalize the Sub band frequency and mode to those of the Main band, hold down **DUAL-W** for 1 second. This Quick Dualwatch function can be turned OFF in the Others set screen. (p. 8-3)
2. Touch the frequency readout of the band you want to set the frequency.
3. Rotate **MAIN DIAL** to set the frequency.

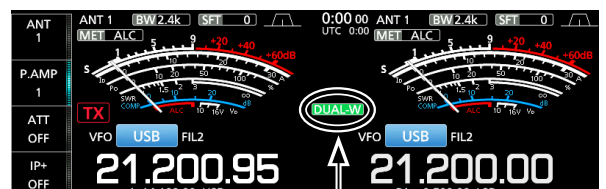

Displayed

Selecting the operating band

◇ Selecting the operating band on the keypad

(Example: Selecting 14 MHz in the Main band.)

1. Touch the Main band's frequency readout.
2. Push [14] on the band keypad.

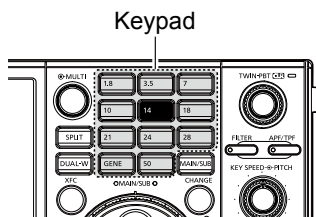

• The 14 MHz band frequency is displayed.



◇ Selecting the operating band on the screen

(Example: Selecting 21 MHz in the Main band.)

1. Touch the MHz digits to display the BAND STACKING REGISTER screen.



2. Touch [21].



About the Band Stacking Register:

The band stacking register provides 3 memories for each band key to store frequencies and operating modes.

Sequentially select the registered memories:

- Repeatedly push a band key on the keypad.
- Repeatedly touching a band key on the BAND STACKING REGISTER screen for 1 second.

Selecting the operating mode

You can select the SSB, CW, RTTY, PSK, AM, or FM modes.

1. Touch the mode icon.



2. Touch the mode key.
 - ① In the SSB, AM or FM mode, the [DATA] key is displayed.



• Operating mode selection list

Mode key	Operating mode	
[SSB]	LSB	USB
[CW]	CW	CW-R
[RTTY]	RTTY	RTTY-R
[PSK]	PSK	PSK-R
[AM]	AM	
[FM]	FM	
[DATA]	LSB	LSB-D
	USB	USB-D
	AM	AM-D
	FM	FM-D

Selecting the Data mode

You can operate in the Data mode in the SSB, AM and FM modes. The Data mode enables you to operate in these modes with input from various connectors, even if the microphone is connected.

- ① When the data mode is selected, you can select the connector that will input the modulation signal. (p. 8-6)

MENU » SET > Connectors > DATA OFF MOD, DATA1 MOD ~ DATA3 MOD

- Select the connector(s) to input the modulation signal.

(Example: USB-D mode)

1. While the USB mode is selected, touch the mode icon.
2. Touch [DATA].
 - [USB-D1] is displayed.
 - The selected connector will be used to input the modulation signal.

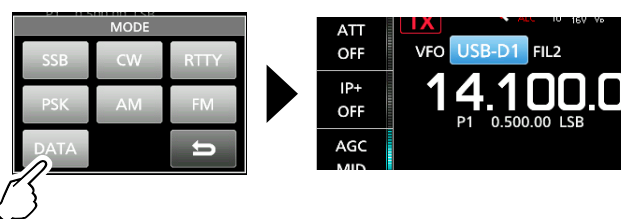

TIP: See page 36 in the *Advanced Manual* for details on using the AFSK Data mode.

Setting the frequency

◇ Using the Main Dial

1. Select the operating band. (Example: 21 MHz)



2. Rotate **MAIN DIAL**.

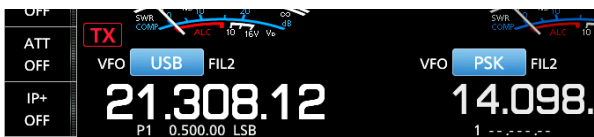

① **TX** is displayed when you set an amateur radio frequency, and **TX** (“TX” with a border of short dashes) is displayed when you set a frequency outside the Ham band, or outside your set Band Edges.

◇ Setting the Tuning Step function

You can set **MAIN DIAL**'s tuning step for each operating band. This is convenient to change the operating frequency faster or slower. The following steps are set as default.

- SSB/CW/RTTY/PSK (TS OFF): 10 Hz
- AM (TS ON): 1 kHz
- FM (TS ON): 10 kHz

Touch the kHz digits to turn the Tuning Step function ON or OFF.

① The Tuning Step function's icon “▼” is displayed above the 1 kHz digit when the function is ON.

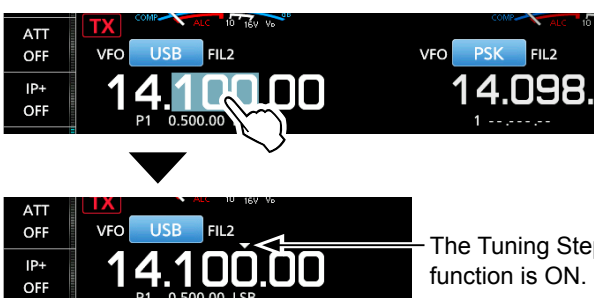

The Tuning Step function is ON.

◇ Changing the Tuning Step

When the Tuning Step function is ON, you can change the tuning steps for each operating mode.

1. Select the desired operating mode.
2. Touch the kHz digit for 1 second.



3. Touch the tuning step. (Example: 0.1 k)
 - The tuning step is set and returns to the previous screen.



The Tuning Step function is ON.

◇ Using the 1 Hz step Fine Tuning function

You can use the minimum tuning step of 1 Hz for fine tuning in the SSB, CW and RTTY modes as the default.

Touch the Hz digits for 1 second to turn the Fine Tuning function ON or OFF.



The 1 Hz digit is displayed.

① When using the [UP]/[DN] keys on the microphone, the frequency changes in 50 Hz steps with the Fine Tuning function ON or OFF.

Setting the frequency (Continued)

◇ Using the 1/4 Tuning function

With the Tuning Function OFF, turn ON the 1/4 Tuning function to reduce the tuning speed to 1/4 of the normal speed, for finer tuning in the SSB-D, CW, RTTY and PSK modes.

1. Push **MENU**.
2. Touch [1/4].

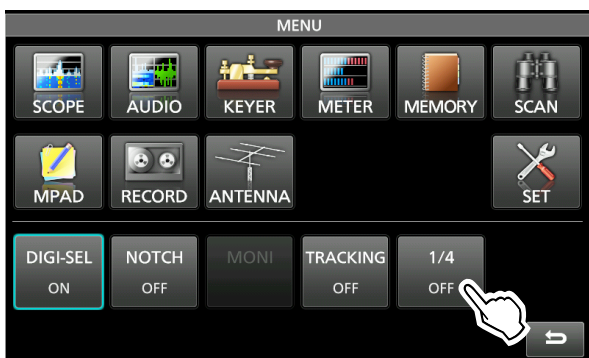

3. Push **EXIT** to close the MENU screen.



◇ Using the Auto Tuning Step function

The tuning step automatically changes, depending on the rotating speed of **MAIN DIAL**.

- ① You can change the Auto Tuning Step function settings in the following menu. (p. 8-4)

MENU » **SET** > Function > **MAIN DIAL Auto TS**

◇ Directly entering a frequency

You can directly enter a frequency using the keypad.

Entering the operating frequency

1. Touch the MHz digits.
(Example: 14)



2. Touch [F-INP].
• Opens the F-INP screen.

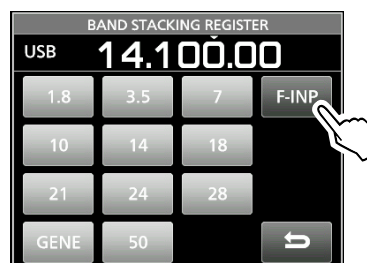

3. Start by entering the MHz digits.
① To clear the entry, touch [CE].
① To clear the entry and return to the previous screen, push **EXIT**.
4. Touch [ENT] to save the entered frequency.
• Closes the F-INP screen.



- ① If you touch [ENT] when the digits under 100 kHz are not entered, "0" will be automatically entered into the digits that are blank.

Entry examples

- 14.025 MHz: [1], [4], [•(-)], [0], [2], [5], [ENT]
- 18.0725 MHz: [1], [8], [•(-)], [0], [7], [2], [5], [ENT]
- 730 kHz: [0], [•(-)], [7], [3], [ENT]
- 5.100 MHz: [5], [•(-)], [1], [ENT]
- 7.000 MHz: [7], [ENT]
- Changing from 21.280 MHz to 21.245 MHz: [•(-)], [2], [4], [5], [ENT]

Setting the frequency (Continued)

Entering a Split Frequency Offset

- On the F-INP screen, enter the Split Frequency Offset.
 - To enter a minus shift direction, touch [•(-)].
 - Enter an offset between -9.999 MHz and +9.999 MHz (1 kHz steps).

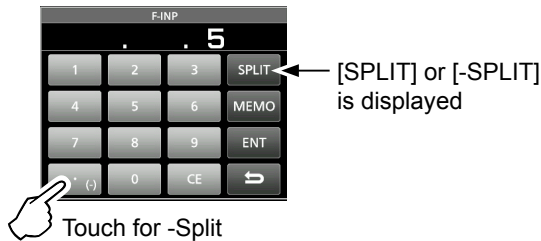

Entry examples

- 10 kHz: [1], [0], [SPLIT]
- -1.025 MHz: [•(-)], [1], [0], [2], [5], [-SPLIT]

- To save the entry, touch [SPLIT] or [-SPLIT].
 - Closes the F-INP screen, and the Split function is automatically turned ON.

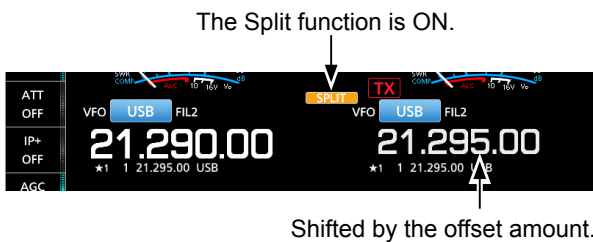

Entering a Memory channel

- Push **QUICK**, and touch “VFO/MEMORY.”
- Touch [MEMORY] to select the Memory mode.

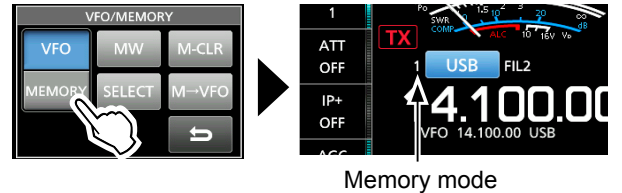

- Touch the MHz digits.

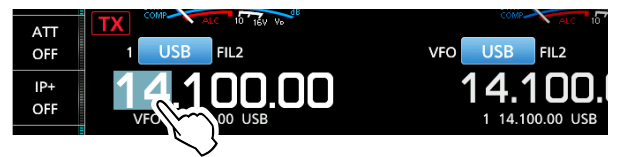

- Touch [F-INP].

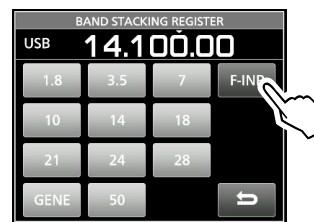

- Enter a Memory channel number between 1 and 99. (Example: Memory channel 5)
 - If you want to set a Program Channel number (P1 or P2), enter “100” for P1, and “101” for P2.
- Touch [MEMO] to save the entered channel.



- Closes the F-INP screen.

Dial Lock function

The Dial Lock function prevents frequency changes caused by accidentally rotating (**MAIN DIAL**).
 This function electronically locks the dial.

Hold down **SPEECH** for 1 second to turn the Dial Lock function ON or OFF.

- “**LO**” is displayed while the function is ON.
- During Split Frequency operation, the Split Lock function may be turned ON. (p. 4-10)

MENU » **SET > Function > Lock Function**

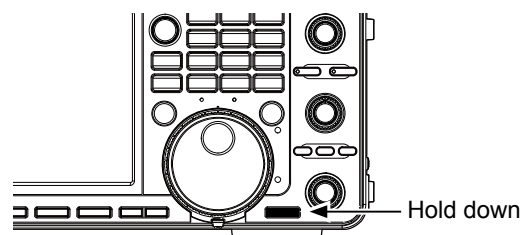

RF gain and SQL level

Rotate **(AF/RF/SQL)** (outer) to adjust the RF gain and SQL level.

By default, rotating to the left (when set to the 12 o'clock position) adjusts the RF gain, and rotating to the right adjusts the squelch level, as described below.

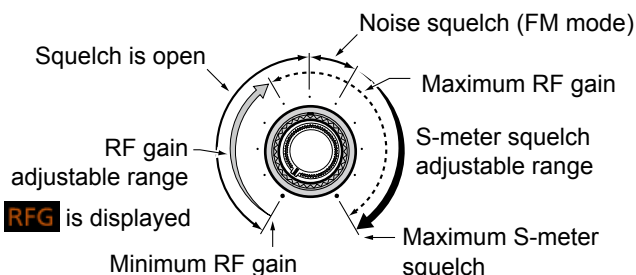

RF gain

You can adjust the receive sensitivity.

- If a strong interfering signal is received, rotate **(AF/RF/SQL)** (outer) counterclockwise to reduce the RF gain.
 - ① "RFG" is displayed to indicate that the gain is reduced.
 - ① If a strong signal is received and "OVF" (Overflow) appears, reduce the RF gain until "OVF" disappears.

Squelch (SQL) level

There are 2 types of squelch, depending on the operating mode.

Noise squelch

Rotate the **(AF/RF/SQL)** (outer) until the noise just disappears and the TX/RX indicator goes OFF.

S-meter squelch

The S-meter squelch disables the audio output from the speaker or headphones when the received signal is weaker than the specified S-meter squelch level.

Rotate the **(AF/RF/SQL)** clockwise from the 12 o'clock position to increase the S-meter threshold level.

- ① You can change the **(AF/RF/SQL)** (outer) control type in "RF/SQL Control." (p. 8-3)

MENU » **SET > Function > RF/SQL Control**

Meter display

◇ Selecting the Meter readout

Select one of the 6 different transmit parameters (Po, SWR, ALC, COMP, Vd and Id) to display during transmit.

Touch the meter to display one of the meters.

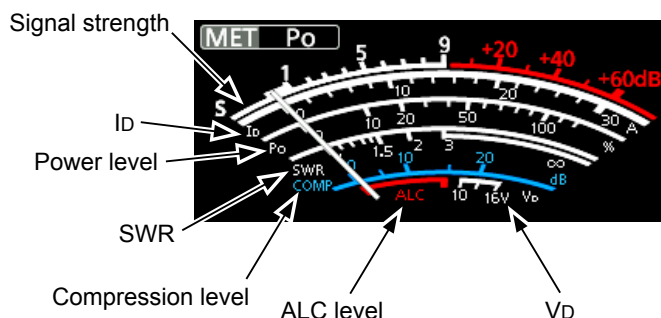
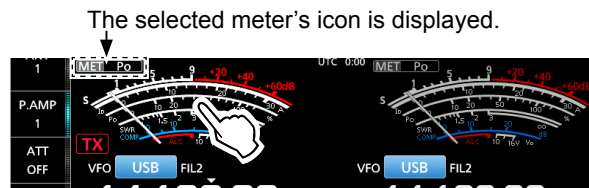

◇ About the Multi-function meter

- S:** Displays the receiving signal strength level.
- Po:** Displays the relative RF output power.
- SWR:** Displays the SWR of the antenna at the selected frequency.
- ALC:** Displays the ALC level. When the meter movement shows the input signal level exceeds the allowed level, the ALC limits the RF power to suppress signal distortion. In such cases, decrease the microphone gain level.
- COMP:** Displays the compression level when the speech compressor is used.
- Vd:** Displays the drain voltage of the final amplifier MOS-FETs.
- Id:** Displays the drain current of the final amplifier MOS-FETs.
- TEMP:** Displays the temperature of the final amplifier MOS-FETs.

Meter display (Continued)

◇ **Displaying the Multi-function meter**

You can simultaneously display all the parameters.

- ① The TEMP meter is also displayed on the Multi-function meter.
- Touch the meter for 1 second to display the Multi-function meter.
 - ① To close the Multi-function meter, touch the meter for 1 second again.
- While the Multi-function meter is displayed, touch [P-HOLD] to turn ON the Peak Level Hold function.
 - “P-HOLD” is displayed on the Multi-function meter window title.
 - ① To turn OFF, push **EXIT**.

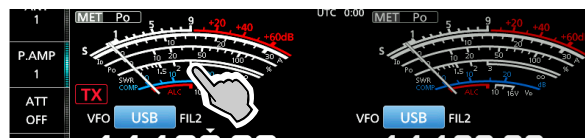

Displayed when Peak Hold function is ON.

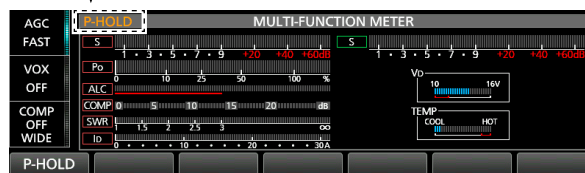

Adjusting the transmit output power

Before transmitting, monitor your selected operating frequency to make sure you do not cause interference to other stations on the same frequency. It is good amateur practice to listen first, and then, even if nothing is heard, ask if the frequency is in use once or twice, before you start operating.

◇ **Adjusting the transmit output power**

1. Set the operating mode to SSB, CW, RTTY, PSK or FM. (p. 3-3)
2. Touch the meter several times to display the Po meter.
 - **MET Po** is displayed.

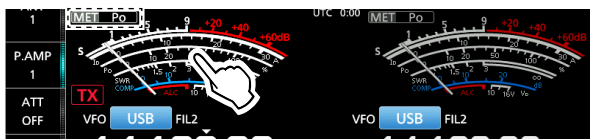

5. Touch “RF POWER.”
6. Rotate **⊖MULTI** to adjust the transmit output power to between 0 and 100%.

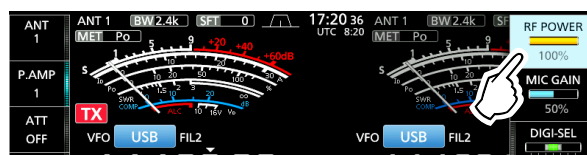

3. Push **⊖MULTI** to open the Multi-function menu.
4. Hold down [PTT] (or push **TRANSMIT**).
 - The Po meter level changes according to your voice level in the SSB mode.
 - The TX/RX indicator lights red and **TX** is displayed.
- ① Tune the antenna before you view the power meter level on the meter. If the antenna is not tuned properly, the meter will not reflect the power level.

- The Po meter displays the RF output power in a percentage. It becomes the S-meter while receiving.
- 7. Release [PTT] (or push **TRANSMIT** again).
 - Returns to receive.

Adjusting the microphone gain

Adjust the microphone gain as described below.

1. Set the operating mode to SSB, AM or FM.
(p. 3-2)
2. Push **[MULTI]** to display the Multi-function menu.
3. Touch "MIC GAIN."

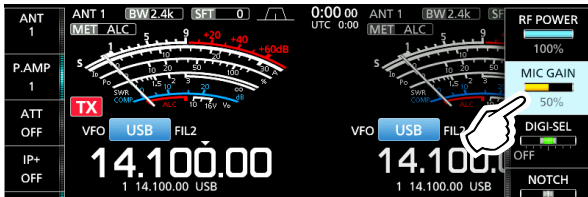

4. Hold down [PTT] on the microphone.
 - The TX/RX indicator lights red and **TX** is displayed.
5. Rotate **[MULTI]** to adjust the microphone gain.
6. Release [PTT].
 - Returns to receive

① Information

- In the SSB mode, touch the TX meter to select the ALC meter, and adjust until the meter reading swings between 30 to 50% of the ALC scale, when speaking into the microphone at your normal voice level.
- In the AM or FM mode, check the audio clarity with another station, or use the Monitor function (p. 4-7).

Basic transmission

1. Hold down [PTT] (or push **[TRANSMIT]**) to transmit.
 - The TX/RX indicator lights red and **TX** is displayed while transmitting.
2. Release [PTT] (or push **[TRANSMIT]** again).
 - Returns to receive.

Preamplifiers

The preamps amplify received signals in the receiver front end to improve the signal-to-noise ratio and sensitivity. A preamp is used when the received signals are weak.

① Each band memorizes the previously used Preamp setting.

Touch [P.AMP].

① Each touch sequentially selects "P.AMP 1," "P.AMP 2," and "P.AMP OFF."

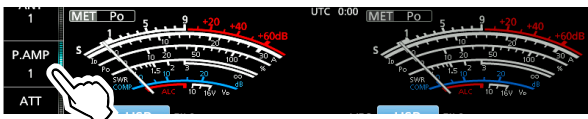

P.AMP 1	Wide dynamic range preamplifier. It is most effective for the HF low bands. • Gain is approximately 12 dB.
P.AMP 2	High-gain preamplifier. It is most effective for the higher bands. • Gain is approximately 20 dB.

NOTE:

- When you use the preamp while receiving strong signals, the receiving signal may be distorted. In such case, turn OFF the preamp.
- While the Digital Selector is ON, "P.AMP OFF" is fixed, and you cannot select "P.AMP 1" or "P.AMP 2."

Attenuator

The Attenuator prevents a signal from becoming distorted when a very strong signal is being received near your operating frequency, or when a very strong electric field, such as from a broadcasting station.

Touch [ATT] to sequentially set the Attenuator up to 18 dB in 6 dB steps.



You can also set the Attenuator in 3 dB steps:

1. Touch [ATT] for 1 second to open the ATT menu.

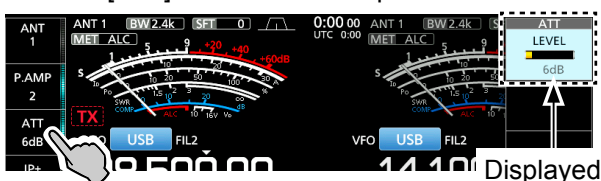

2. Rotate [MULTI] to adjust the attenuator level of up to 45 dB.

RIT function

The RIT (Receive Increment Tuning) function compensates for differences in the transmit frequencies of other stations.

The function shifts your Main band's receive frequency up to ± 9.99 kHz without shifting your transmit frequency.

1. Push [RIT] to turn ON the RIT function.

① While using the Fine Tuning function (p. 3-4), the RIT frequency is displayed in 4 digits, instead of 3.

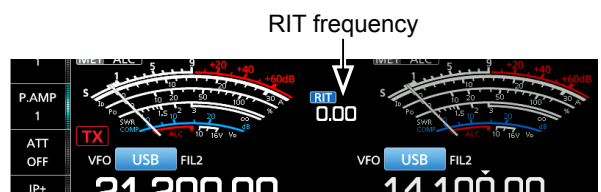

2. Rotate [RIT/ATX] to set the RIT frequency to match the transmitting station's frequency.

① You can reset the RIT frequency to "0.00" by holding down [CLEAR] for 1 second.

① You can add the frequency shift to your operating frequency by holding down [RIT] for 1 second.

3. When you have finished communicating, push [RIT] to turn the RIT function OFF.

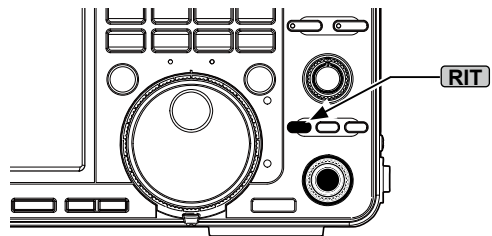

◇ Using the RIT Monitor function

When the RIT function is ON, you can monitor your operating frequency while holding down [XFC].

① While monitoring:

- The RIT function is temporarily OFF.
- The Noise Reduction, Notch filter and Twin PBT settings are temporarily OFF.

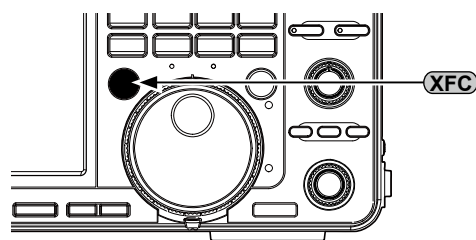

AGC function control

The AGC (Automatic Gain Control) controls receiver gain to produce a constant audio output level, even when the received signal strength varies greatly.

◇ Selecting the AGC time constant preset value

The transceiver has FAST, MID and SLOW preset AGC settings for all modes, except for the FM mode.

1. Select the operating mode.
(Example: SSB)
2. Touch [AGC] to sequentially select FAST, MID or SLOW.
①FAST is fixed in the FM mode.



◇ Setting the AGC time constant

You can set the preset AGC time constant.

1. Select the operating mode.
(Example: SSB)
2. Touch [AGC] for 1 second.
• Opens the AGC screen.



3. Touch FAST, MID or SLOW.
4. Rotate (MAIN DIAL) to set the time constant.



①You can reset to the default settings by touching [DEF] for 1 second.

5. To close the AGC screen, push (EXIT).

• Selectable AGC Time constant (unit: seconds)

Mode	Default	Adjustable time constant
LSB USB	0.3 (FAST)	OFF, 0.1, 0.2, 0.3, 0.5, 0.8, 1.2, 1.6, 2.0, 2.5, 3.0, 4.0, 5.0 or 6.0
	2.0 (MID)	
	6.0 (SLOW)	
CW RTTY PSK	0.1 (FAST)	OFF, 0.1, 0.2, 0.3, 0.5, 0.8, 1.2, 1.6, 2.0, 2.5, 3.0, 4.0, 5.0 or 6.0
	0.5 (MID)	
	1.2 (SLOW)	
AM	3.0 (FAST)	OFF, 0.3, 0.5, 0.8, 1.2, 1.6, 2.0, 2.5, 3.0, 4.0, 5.0, 6.0, 7.0 or 8.0
	5.0 (MID)	
	7.0 (SLOW)	
FM	0.1 (FAST)	Fixed

NOTE: When you are receiving weak signals, and a strong signal is momentarily received, the AGC function quickly reduces the receiver gain. When that signal disappears, the transceiver may not receive the weak signal because of the AGC action. In that case, select FAST, or touch [AGC] for 1 second to open the AGC screen, and then select OFF.

Using the Twin PBT

SSB, CW, RTTY, PSK and AM modes

To reject interference, the Twin PBT (Passband Tuning) narrows the IF passband width by electronically shifting the IF frequency slightly above or below the IF center frequency. The IC-7610 uses DSP for the PBT function.

1. Rotate **TWIN PBT CLR** inner (PBT1) and outer (PBT2) in the opposite direction from each other.

Information

- Match both the **TWIN PBT CLR** (inner) (PBT1) and outer (PBT2) filters before operating the Twin PBT.
- Rejects interference of both higher and lower passbands.
- If you rotate the control too much, the received audio may not be heard because the passband width is too narrow.
- Displays the passband width and shift value.
- Hold down **TWIN PBT CLR** for 1 second to clear the PBT setting.
- The PBT is adjustable in 50 Hz steps in the SSB, CW, and RTTY modes, and 200 Hz in the AM mode. In this case, the center shift value changes in 25 Hz steps in the SSB, CW, and RTTY modes, and 100 Hz in the AM mode.
- Rotating both the inner and outer controls together to the same position shifts the IF left or right.

2. Hold down **FILTER** for 1 second to display the current passband width and shift frequency.
 - Opens the FILTER screen.
3. To close the FILTER screen, push **EXIT**.

NOTE: While rotating **TWIN PBT CLR**, you may hear noise. This comes from the DSP unit and does not indicate an equipment malfunction.

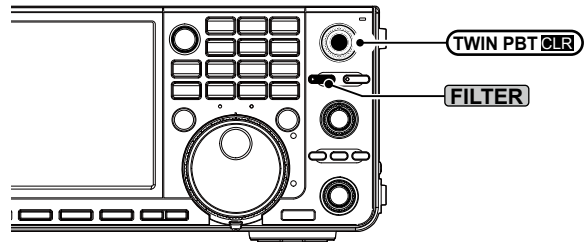

• When rotating **TWIN PBT CLR**

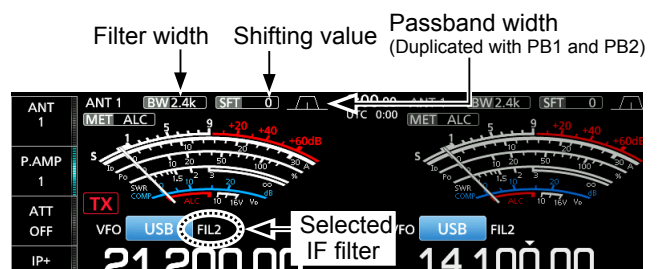

• The FILTER screen when rotating **TWIN PBT CLR**

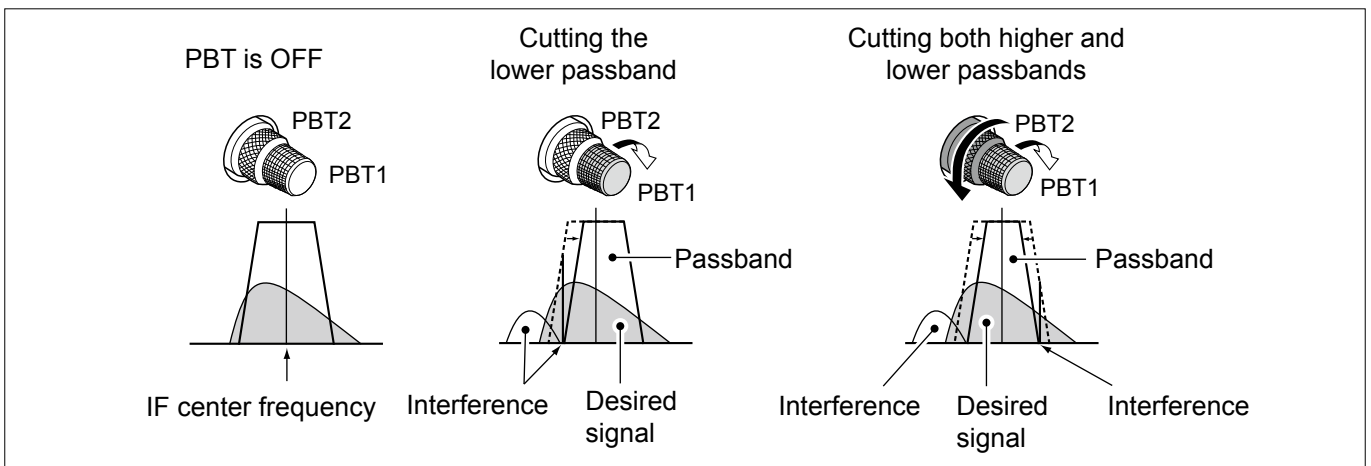
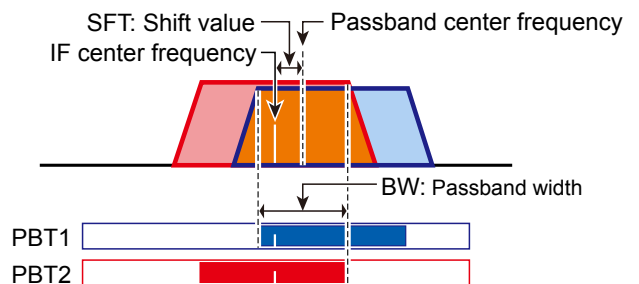
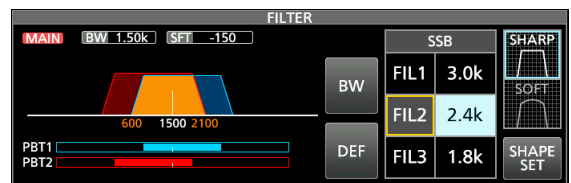

Selecting the IF filter

The transceiver has 3 IF filter passband widths for each mode, and you can select them on the FILTER screen. You can set the IF filter to FIL 1 (wide), FIL 2 (mid) or FIL 3 (narrow).

1. Select the operating mode.
(Example: USB)
2. Hold down **[FILTER]** for 1 second.
• Opens the FILTER screen.
3. Touch FIL 1 (wide), FIL 2 (mid) or FIL 3 (narrow).



4. Touch **[BW]**.
• Selects the passband width mode.
5. Rotate **(MAIN DIAL)** to select the passband width.
 - ① You cannot change the passband width in the FM or FM-D mode.
 - ② When you change the passband width, the Twin PBT setting value is reset to the center position.



Displayed when the selected band width is 500 Hz or narrower, in the SSB or CW mode.



Touch for 1 second to reset to default

6. Touch **[BW]**.
• Cancels the passband width mode.
7. Repeat steps 3 to 5 to set the passband width for other modes except for the FM and FM-D modes.
8. To close the FILTER screen, push **[EXIT]**.

TIP: When you set the IF filter to FIL2 or FIL3 in the FM mode, the transceiver will transmit in the FM narrow mode.

Mode	IF filter	Selectable range (steps)
SSB	FIL 1 (3.0 kHz)	50 Hz to 500 Hz (50 Hz)/ 600 Hz to 3.6 kHz (100 Hz)
	FIL 2 (2.4 kHz)	
	FIL 3 (1.8 kHz)	
SSB-D	FIL 1 (3.0 kHz)	50 Hz to 500 Hz (50 Hz)/ 600 Hz to 3.6 kHz (100 Hz)
	FIL 2 (1.2 kHz)	
	FIL 3 (500 Hz)	
CW PSK	FIL 1 (1.2 kHz)	50 Hz to 500 Hz (50 Hz)/ 600 Hz to 3.6 kHz (100 Hz)
	FIL 2 (500 Hz)	
	FIL 3 (250 Hz)	
RTTY	FIL 1 (2.4 kHz)	50 Hz to 500 Hz (50 Hz) 600 Hz to 2.7 kHz (100 Hz)
	FIL 2 (500 Hz)	
	FIL 3 (250 Hz)	
AM AM-D	FIL 1 (9.0 kHz)	200 Hz to 10.0 kHz (200 Hz)
	FIL 2 (6.0 kHz)	
	FIL 3 (3.0 kHz)	
FM FM-D	FIL 1 (15 kHz)	Fixed
	FIL 2 (10 kHz)	
	FIL 3 (7.0 kHz)	

Selecting the IF filter shape

You can independently set the DSP filter shape to soft or sharp for each operating mode.

1. Set the operating mode to SSB or CW.
(Example: USB)
2. Hold down **[FILTER]** for 1 second.
• Opens the FILTER screen.
3. Select FIL1 (wide), FIL2 (mid) or FIL3 (narrow).
4. Touch **[SHARP]** or **[SOFT]**.

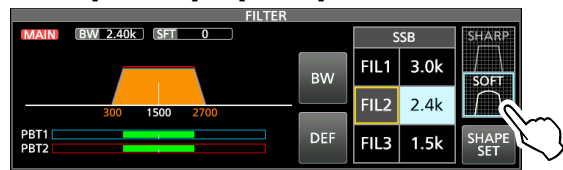

5. To close the FILTER screen, push **[EXIT]**.

• SHARP

This selection is to emphasize the passband width of the filter. The filter has an almost ideal shape factor. Signals of the out of passband are extremely filtered out and it gives you better audio quality.

• SOFT

The filter shoulders are roundly formed as in analog filters. This decreases noise components in the high and low frequencies of the filter passband and increases the S/N of the target signal. These characteristics play an effective role in picking up very weak signals in the 50 MHz band, for example. The shape factor is kept, and the sharpness of the bandpass is excellent.

Noise Blanker

The Noise blanker eliminates pulse-type noise such as the noise from car ignitions.

The Noise blanker cannot be used in the FM mode.

Push **[NB]** to turn the Noise Blanker ON or OFF.

- The Noise Blanker indicator on **[NB]** lights.

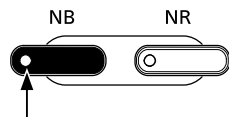

NOTE: When using the Noise Blanker, received signals may be distorted if they are excessively strong, or the noise is other than a pulse type. In that case, turn OFF the Noise Blanker, or shallow the DEPTH on the NB menu. See the instruction below for details.

◇ Adjusting the NB level and time

To deal with various types of noise, you can adjust the attenuation level and the blanking depth and width in the NB menu.

1. Hold down **[NB]** for 1 second.
 - Turns ON the Noise Blanker and opens the NB menu.
2. Touch the adjusting item.



3. Rotate **[MULTI]** to adjust the item. (Example: 8)



4. Push **[MULTI]** to set and close the NB menu.

LEVEL (Default: 50%)

Adjust the level where the Noise Blanker activates between 0 and 100%.

DEPTH (Default: 8)

Adjust the noise attenuation depth between 1 and 10.

WIDTH (Default: 50)

Adjust the blanking duration time between 1 and 100.

Noise Reduction

The Noise Reduction reduces random noise components and enhances signal audio.

Push **[NR]** to turn the Noise Reduction ON or OFF.

- The Noise Reduction indicator on **[NR]** lights.

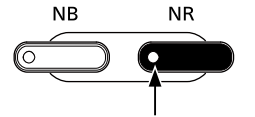

◇ Adjusting the Noise Reduction level

Adjust the Noise Reduction level to where noise is reduced but the received signal is not distorted.

1. Hold down **[NR]** for 1 second.
 - Turns ON the Noise Reduction and opens the NR menu.
2. Rotate **[MULTI]** to adjust the Noise Reduction level to between 0 and 15.
 - ① Adjust to a higher level to increase the reduction level, and to a lower level to decrease it.



Noise Reduction OFF
NR level 0

Noise components

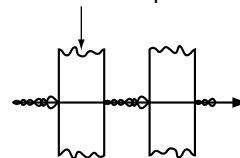

Noise Reduction ON
NR level 4

Desired signal (CW)

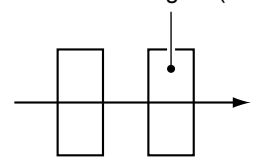

3. Push **[EXIT]** to close the NR menu.

Digital Selector

You can manually adjust the center frequency of the automatic preselector using the Digital Selector function.

The automatic preselector adds selectivity ahead of the 1st mixer. This reduces intermodulation distortion from nearby strong signals. The automatic preselector tracks the frequency tuning by changing its resonant frequency in discrete steps. The Digital selector is used within the ham band, except for the 50 MHz band.

◇ Turning ON the Digital Selector function

1. Push **[MENU]** to open the MENU screen.
2. Touch **[DIGI-SEL]** to turn ON the Digital Selector function ON.
- ① Touching **[DIGI-SEL]** to turn the function ON or OFF.



◇ Adjusting the center frequency

1. While the MENU screen is displayed, touch **[DIGI-SEL]** for 1 second.
 - The Multi-function menu is displayed, and the Digital Selector adjustment is automatically selected.

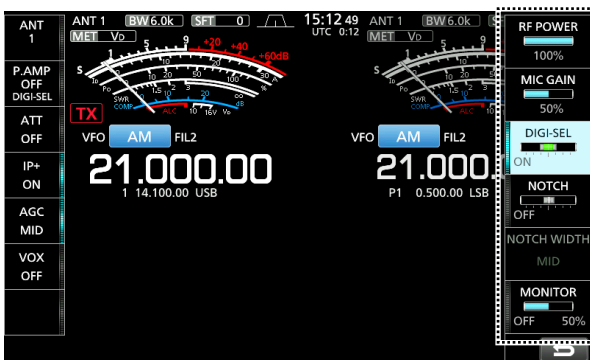

2. Rotate **[MULTI]** to adjust the center frequency.
3. To close the Multi-function menu, push **[EXIT]**.

NOTE:

- When you rotate **[MAIN DIAL]** while the Digital Selector is ON, mechanical noise may be heard due to the switching noise from internal relays.
- The P.AMP 1 or P.AMP 2 preamps cannot be used while using the Digital Selector.

Notch Filter

The IC-7610 has Auto Notch and Manual Notch functions.

Auto Notch can be used in the SSB, AM and FM modes, and Manual Notch can be used in the SSB, CW, RTTY, PSK, and AM modes.

◇ Selecting the Notch function type

1. Push **[MENU]**.
2. Touch **[NOTCH]** to select the Notch function type.
 - ① Touching **[NOTCH]** changes between “AN (Auto Notch),” “MN (Manual Notch)” and OFF.
 - “AN” is displayed when the Automatic Notch function is ON, and “MN” is displayed when the Manual Notch function is ON.

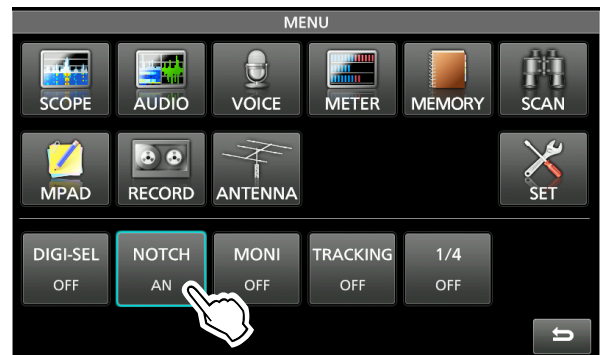

3. To close the MENU screen, push **[EXIT]**.

◇ Auto Notch function

The Auto Notch automatically attenuates beat tones, tuning signals, and so on.

- ① “AN” is displayed when the Automatic Notch function is ON.



Notch Filter (Continued)

◆ Manual Notch function

The Manual Notch attenuates beat tones, tuning signals and so on by adjusting the Notch filter's center frequency.

1. Touch [NOTCH] for 1 second.
 - The Multi-function menu is displayed, and the Notch position setting is automatically selected.

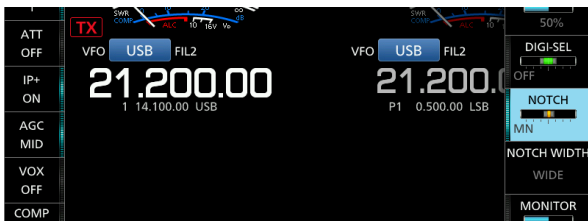
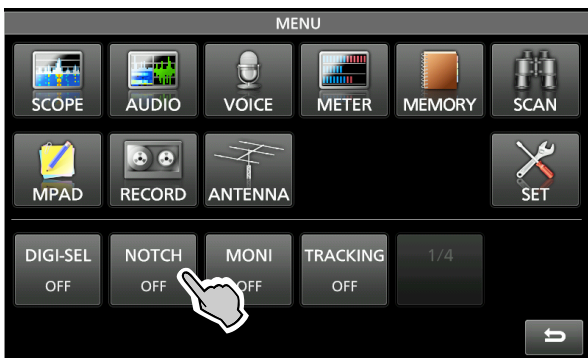

2. Rotate **[MULTI]** to manually attenuate the frequency.



① Touching [NOTCH WIDTH] changes the Manual Notch filter width between "WIDE," "MID," and "NAR."

NOTE: While adjusting, noise may be heard. This comes from the DSP unit but it does not indicate an equipment malfunction.

Monitor function

The Monitor function enables you to monitor your transmit audio. Use this function to check the voice characteristics while adjusting the transmit audio parameters.

① You can hear the CW sidetone regardless of the Monitor function setting.

1. Select the operating mode that you want to monitor. (Example: AM)
2. Push **[MENU]**.
 - Opens the MENU screen.
3. Touch [MONI] to turn ON the Monitor function.
 - ① Touching [MONI] turns the Monitor function ON or OFF.

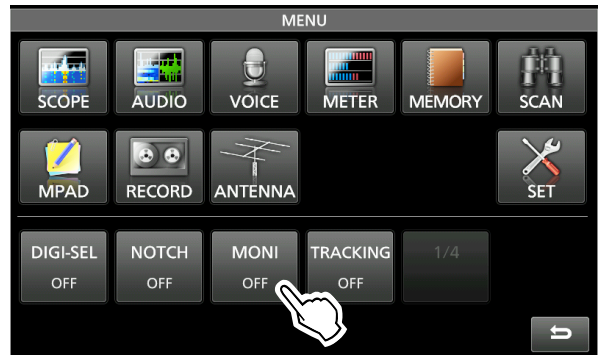

4. Touch [MONI] for 1 second.
 - The Multi-function menu is displayed, and the MONITOR setting is automatically selected.

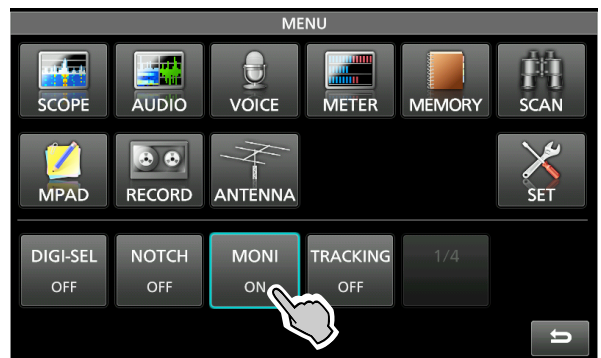

5. Rotate **[MULTI]** to adjust MONITOR to the clearest audio output between 0% and 100%, while speaking at your normal voice level.



NOTE: When using the VOICE DELAY set in the VOX menu, turn OFF the Monitor function. Otherwise the transmitted audio will echo.

Speech Compressor (SSB)

The Speech Compressor increases the average RF output power, improving readability at the receiving station. This function compresses the transmitter audio input to increase the average audio output level.

① The function is effective for long-distance communication, or when propagation conditions are poor.

1. Select the SSB mode.
2. Be sure the Speech Compressor is OFF.
 - ① If it is ON, touch [COMP] to turn it OFF.

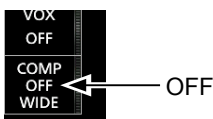

3. Touch the meter to display the ALC meter.
 - ① Touching the meter sets the meter to Po, SWR, ALC, COMP, Vd or Id.

Select the ALC meter.



4. Push **[MULTI]** to display the Multi-function menu.
5. Touch **[MIC GAIN]**, and then adjust it by speaking into the microphone (p. 3-9) to where the ALC meter reads within the 30 to 50% range of the ALC zone.

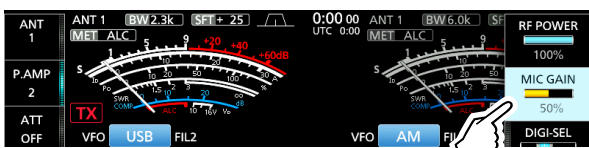

6. Touch the meter again to display the COMP meter.

7. Touch **[COMP]** for 1 second to turn the Speech Compressor ON, and to display the COMP menu.
 - The Speech Compressor Level setting is automatically selected.

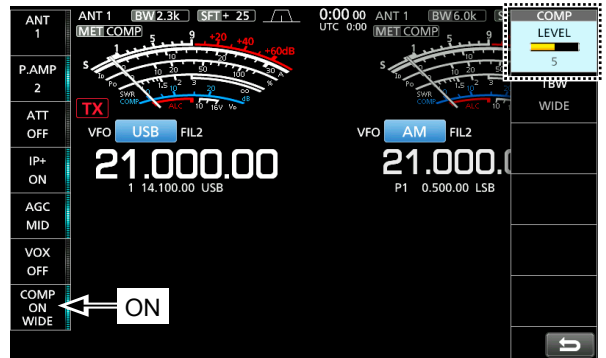

8. While speaking into the microphone at your normal voice level, adjust the Speech Compressor level to where the COMP meter reads within the COMP zone (10 to 20 dB range).
 - ① If the COMP meter peaks exceed the COMP zone, your transmitted voice may be distorted.

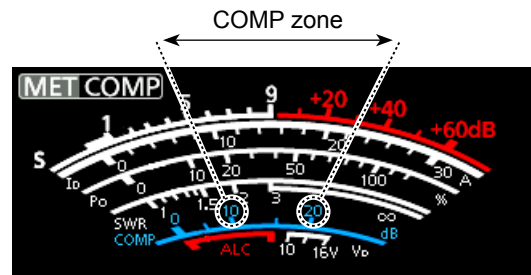

Auto Tuning function (AM/CW)

When an off-frequency signal is received, the Auto Tuning function tunes the signal within a ± 500 Hz range in the CW mode, or a ± 5 kHz range in the AM mode. You can use this function only in the CW and AM modes.

1. Select the AM mode or CW mode.
2. Push **[AUTO TUNE]** to start the Auto Tuning.
 - ① While using the RIT function, the RIT frequency is automatically tuned by this function.

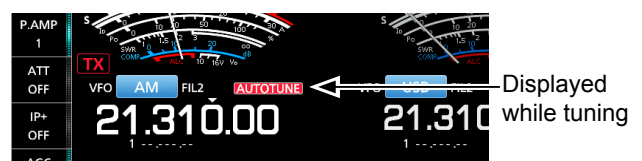



NOTE: When receiving a weak signal, or receiving a signal with interference, the Auto Tuning function may tune the receiver to an undesired signal, or may not start tuning. In such case, a warning beep sounds.

Split frequency operation

Split frequency operation enables you to transmit and receive on different frequencies on the Main band and the Sub band.

There are 2 ways to use the Split frequency operation.

- Using the Quick Split function
- Using the receive and transmit frequencies set to the Main band and Sub band.

The other station		My station	
Transmit frequency	USB mode 21.29000 MHz	Main band Receive frequency	
Receive frequency	USB mode 21.29500 MHz	Sub band Transmit frequency	

◇ Using the Quick Split function

The Quick Split function enables you to automatically equalize the Main band's frequency and mode to the Sub band, and then activate the Split function.

1. Set the Main's receive frequency and operating mode.
(Example: 21.29000 MHz in the USB mode)
2. Hold down **[SPLIT]** for 1 second.
 - The Quick Split function is turned ON, and the Split icon is displayed.
 - The Main band settings are set to the Sub band.

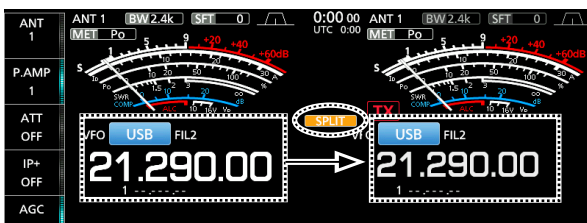

3. While holding down **[XFC]**, set the operating frequency offset between transmit and receive.

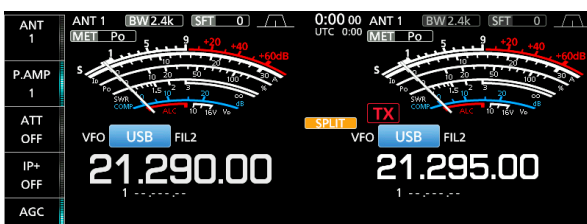

◇ Using the receive and transmit frequencies set to Main and Sub

1. Set Main band's receive frequency and operating mode.
(Example: 21.29000 MHz in the USB mode)
2. Touch the Sub band's frequency readout to select the Sub band, and then set the receive frequency and the operating mode.
(Example: 21.29500 MHz in the USB mode)



3. Push **[SPLIT]**.
 - The Split function is turned ON, and the Split icon is displayed.
 - ① Pushing **[SPLIT]** turns the Split function ON or OFF.

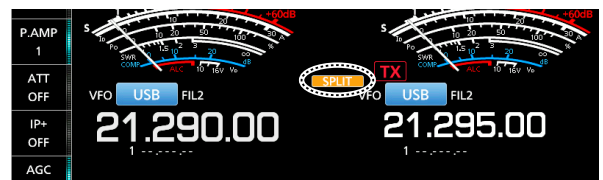

4. Touch the Main band's frequency readout to return to receive on the Main band.
 - ① The Split frequency operation is ready to use.

Split Lock function

To prevent accidentally changing the receive frequency by releasing **[XFC]** while rotating **(MAIN DIAL)**, use the Split Lock function. Using both this function and the Dial Lock function (p. 3-6) enables you to change only the transmit frequency.

1. Turn ON the Split Lock function.
[MENU] » **[SET > Function > SPLIT > SPLIT LOCK]**
2. Turn ON the Split function.
3. Hold down **[SPEECH]** for 1 second to turn ON the Dial Lock function.
4. While holding down **[XFC]**, set the transmit frequency.



Displayed when the Dial Lock function is ON.

Setting the transmit filter width

The transmit filter width for the SSB and SSB-D mode can be set. Only for the SSB mode, WIDE (wide), MID (middle) or NAR (narrow) can be selected.

To change the filter width in the SSB mode:

1. Set the operating mode to USB or LSB.
2. Touch **[COMP]** for 1 second.
• Opens the COMP menu on the right side of the screen.
3. Touch **[TBW]**.
① Touching **[TBW]** sets the filter width to WIDE, MID or NAR.



Screen example in the SSB mode

① The transmit filter widths are set to the following values by default.

- SSB (WIDE): 100 Hz to 2900 Hz
- SSB (MID): 300 Hz to 2700 Hz
- SSB (NAR): 500 Hz to 2500 Hz
- SSB-D: 300 Hz to 2700 Hz

You can change the filter width values in the following settings. (p. 8-2)

[MENU] » **[SET > Tone Control/TBW > TX > SSB > TBW (WIDE)]**

[MENU] » **[SET > Tone Control/TBW > TX > SSB > TBW (MID)]**

[MENU] » **[SET > Tone Control/TBW > TX > SSB > TBW (NAR)]**

[MENU] » **[SET > Tone Control/TBW > TX > SSB-D > TBW]**

Operating CW

◇ Setting the CW pitch control

You can adjust the received CW audio pitch and CW side tone to suit your preference without changing the operating frequency.

1. Select the CW mode.
2. Hold down **[FILTER]** for 1 second.
• The FILTER screen is displayed.
① The FILTER screen graphically displays the CW pitch.

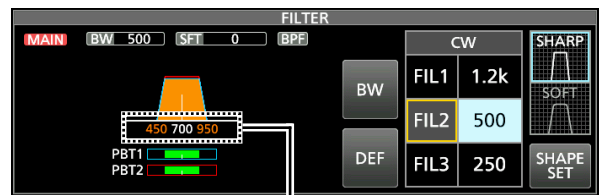

CW pitch frequency display

3. Rotate **(KEY SPEED/PITCH)** (outer) to adjust to between 300 to 900 Hz.

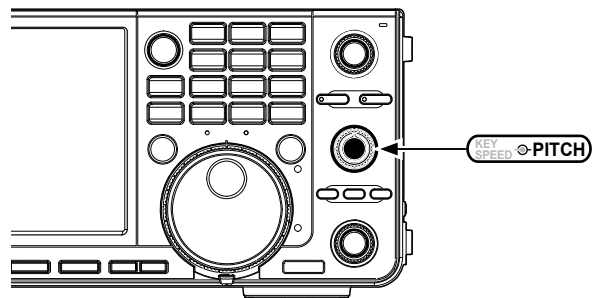

When the selected IF filter is:

- Below 500 Hz, the CW pitch frequency is graphically changed in 5 Hz steps.
- Above 600 Hz, the CW pitch frequency is graphically changed in 25 Hz steps.

4. To close the FILTER screen, push **[EXIT]**.

Operating CW (Continued)

◇ Setting the keying speed

You can set the keying speed of the internal electronic keyer.

1. Select the CW mode.
2. Rotate **KEY SPEED → PITCH** (inner) to set the keying speed to between 6 and 48 WPM (Word Per Minutes).

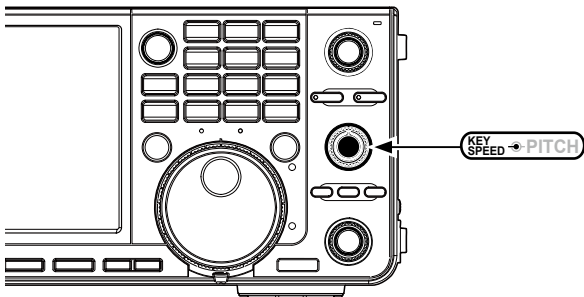

• The keying speed is displayed under the time display while setting.

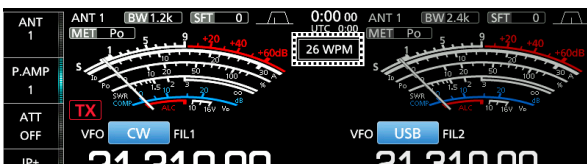

◇ Using the Break-in function

Use the Break-in function in the CW mode to automatically switch between transmit and receive when keying. The IC-7610 is capable of Semi Break-in and Full break-in modes.

TIP: The key type is set to "Paddle" by default. You can select the keyer type on the CW-KEY SET screen. (p. 4-13)

Semi Break-in mode

In the Semi Break-in mode, the transceiver transmits when keying, and then automatically returns to receive after a preset time, after you stop keying.

1. Select the CW mode.
 2. Touch [BK-IN] in the function menu to select "SEMI."
- ① Touching [BK-IN] changes between "BKIN (Semi Break-in)," "F-BKIN (Full Break-in)" or OFF (no indication).

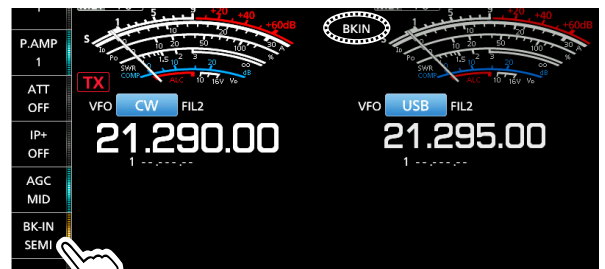

Touch [BK-IN].

3. To adjust the Semi Break-in Delay time, touch [BK-IN] for 1 second.
 - Opens the BKIN menu.



4. Rotate **MULTI** to set to where the transceiver does not return to receive while keying.
 - ① When you are using a paddle, rotate **KEY SPEED → PITCH** (inner) to adjust the key speed while operating the paddle. See the left column for details.
5. To close the BKIN menu, push **EXIT**.

Operating CW

◇ Using the Break-in function (Continued)

Full Break-in mode

In the Full Break-in mode, the transceiver automatically transmits while keying down, and then immediately returns to receive after keying up.

1. Select the CW mode.
2. Touch [BK-IN] in the function menu to select "FULL."
 - ① Touching [BK-IN] changes between "BKIN (Semi Break-in)," "F-BKIN (Full Break-in)" and OFF (no indication).

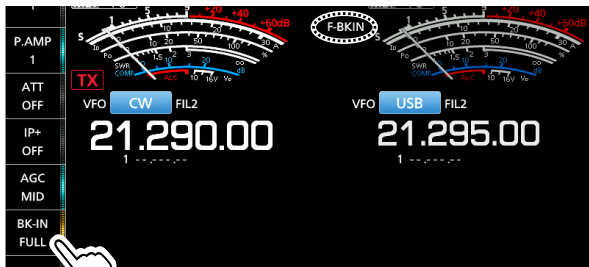

Touch [BK-IN].

3. Use a straight key or paddle to operate.
 - ① In the Full break-in mode, the transceiver automatically returns to receive without a preset break-in delay time after you stop keying. The transceiver receives while keying up.

◇ **Monitoring the CW side tone**

When the transceiver is in standby and the Break-In function is OFF, you can listen to the CW side tone without actually transmitting.

① **Information**

- This enables you to match your transmit frequency exactly to another station's by matching the audio tone.
- You can also use the CW side tone (be sure the Break-in function is OFF) to practice CW sending.
- You can adjust the CW side tone level in "Side Tone Level."

MENU » **KEYER > EDIT/SET > CW-KEY SET > Side Tone Level**

◇ **APF (Audio Peak Filter) operation**

The APF enables you to set excellent selectivity in the CW mode. You can set the selectivity to between the three APF passband width, WIDE, MID or NAR.

1. Select the CW mode.
2. Push **APF/TPF** to turn ON the Audio Peak Filter.

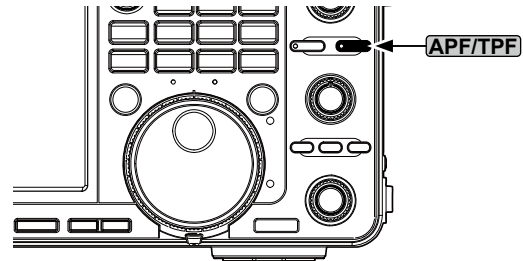

- The APF icon is displayed, and the APF indicator on the key lights.
- ① Pushing **APF/TPF** turns the Audio Peak Filter ON or OFF.
- ① When the APF Type is set to "Sharp" in step 4, the selected passband width of "320 Hz," "160 Hz" or "80 Hz" is displayed under the APF icon for 1 second.



3. Hold down **APF/TPF** for 1 second to open the APF menu.

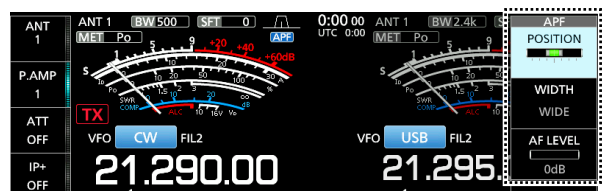

4. Touch to select the item, and then set the audio filter position, passband width, and the audio level.
 - POSITION:** Rotate **(MULTI)** to shift the peak frequency of the APF. This function enables you to avoid interference from adjacent frequencies.
 - WIDTH:** Touch to select WIDE, MID or NAR.
 - TYPE:** Select the audio filter type (soft sound or sharp sound).
 - AF LEVEL:** Set the audio level between 0 dB and +6 dB in 1 dB steps.
5. To close the APF menu, push **EXIT**.

Operating CW (Continued)

◆ About the Electronic Keyer function

You can set the Keyer Memory function settings, paddle polarity settings, and so on of the Electronic Keyer.

1. Open the KEYER SEND screen in the CW mode.

MENU » **KEYER**

① You can select [KEYER] on the MENU screen only in the CW mode.

2. Touch [EDIT/SET].

• Opens the EDIT/SET screen.



KEYER SEND screen

3. Touch to select the item to set.



EDIT/SET screen

4. To close the KEYER SEND screen, push **EXIT** several times.

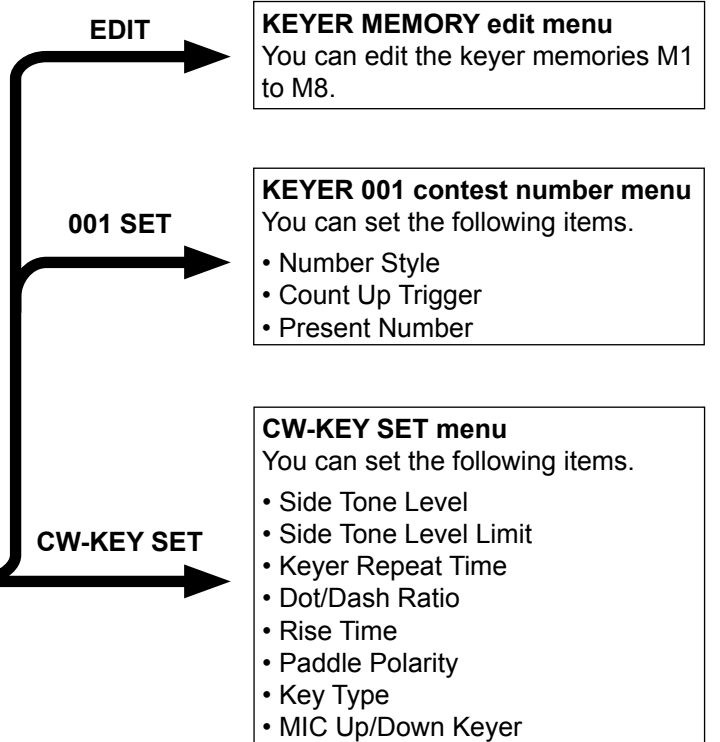

Spectrum scope screen

The spectrum scope enables you to display the activity on the selected band, as well as the relative strengths of various signals.

The transceiver has two spectrum scope modes, the Center mode and the Fixed mode. You can also turn the Waterfall display ON or OFF. In addition, you can select the Mini scope to display it in a smaller size on the screen.

Center mode screen

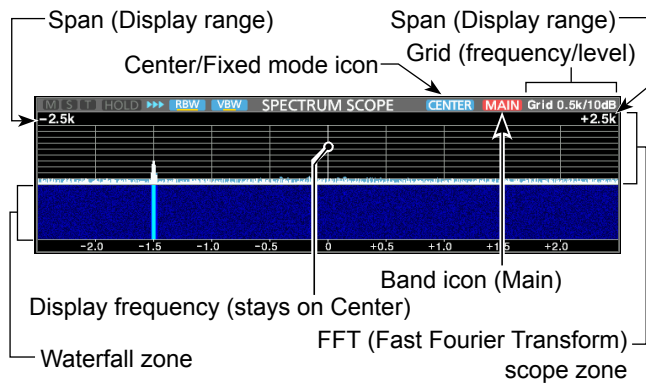

Fixed mode screen

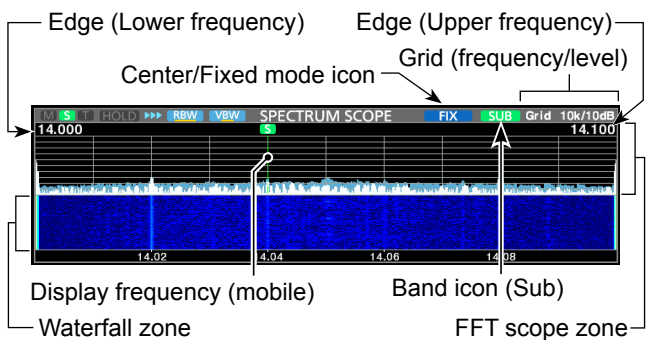

Marker

The marker marks the operating frequencies for both the Main and Sub bands in the SPECTRUM SCOPE screen.

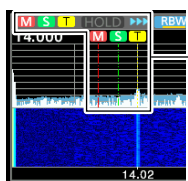

- M:** The Main band marker
 - Marks the Main band frequency.
- S:** The Sub band marker
 - Marks the Sub band frequency.
- T:** The TX marker
 - Marks the transmit frequency.

① In the Center mode, the operating frequency stays on the center of the screen. Therefore, neither the Main band marker on the Main scope, nor the Sub band marker on the Sub scope are displayed.

Using the Spectrum Scope

Display the SPECTRUM SCOPE screen.

[MENU] » SCOPE

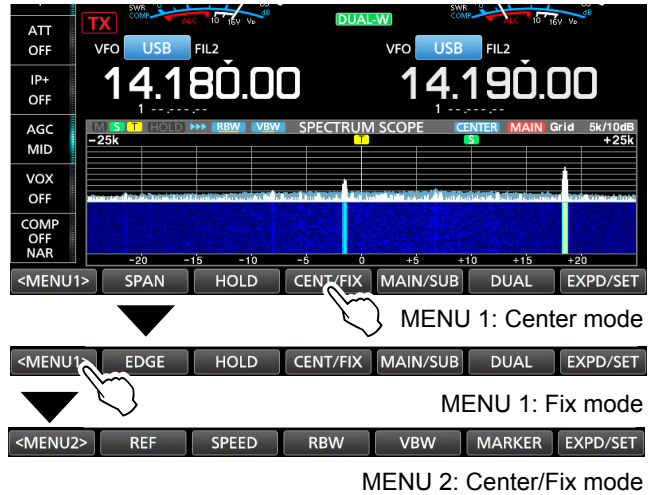

Key	Action	
<MENU1> <MENU2>	Selects the Function menus.	
SPAN	Touch	In the Center mode, selects the scope span. • Spans: ± 2.5 , 5.0, 10, 25, 50, 100, 250 and 500 kHz
	Touch 1 sec.	Resets to the ± 2.5 kHz span.
EDGE	In the Fixed mode, selects the Edge frequencies. ① You can set the upper and lower edge frequencies in the "Fixed Edges" item on the SCOPE SET screen by touching [EXPD/SET] for 1 second.	
HOLD	Touch	Sets the Hold function to ON or OFF. • "[HOLD]" and the marker are displayed. Freezes the current spectrum.
	Touch 1 sec.	Clears the Peak Hold level.
CEN/FIX	Selects the Center or Fixed mode.	
MAIN/SUB	Selects the Main band or Sub band.	
DUAL	Selects the Dual or Single scope.	
EXPD/SET	Touch	Selects the Expanded or Normal screen.
	Touch 1 sec.	Displays the SCOPE SET screen.
REF	Opens the Reference level window. ① Rotate (MAIN DIAL) to adjust the Reference level.	
SPEED	Selects the sweep speed. • "▶▶" (FAST), "▶" (MID) or "▶" (SLOW).	
RBW	Selects the Resolution Band Width from NAR (narrow), MID and WIDE. ① This selection is for the filter that visually separates the spectrum. ① When "NAR" is selected, the signals are finely separated.	
VBW	Selects the Video Band Width from NAR (narrow) and WIDE. ① When "Wide" is selected, the line drawn on the receive spectrum becomes wide. However, the small edge cannot be drawn.	
MARKER	Selects various Markers.	

Spectrum scope screen (Continue)

◇ Displaying the Mini scope screen

The Mini scope screen can be simultaneously displayed with another function display, such as the RTTY DECODE screen or AUDIO SCOPE screen.

Push **M.SCOPE**.

① Pushing it again closes the Mini scope screen.

TIP: Holding down **M.SCOPE** displays the spectrum scope screen, and pushing it again returns to the Mini scope screen.

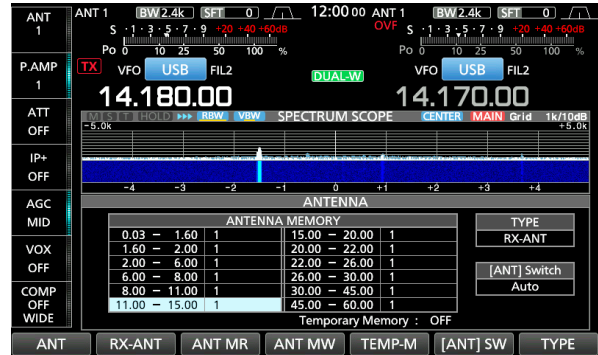

Example: Displaying the Mini scope screen while the ANTENNA screen is displayed.

Audio scope screen

This audio scope enables you to display the received signal's frequency components on the FFT scope, and its waveform components on the Oscilloscope. The FFT scope also has a waterfall display.

• AUDIO SCOPE screen

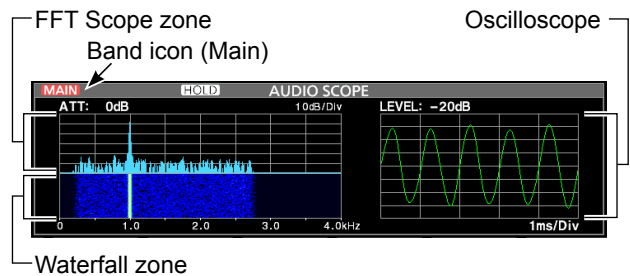

◇ Using the Audio scope

Display the AUDIO SCOPE screen.

MENU » **AUDIO**

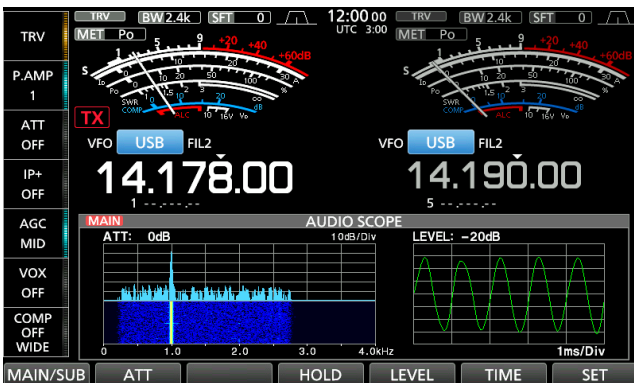

Key	Action	
MAIN/SUB	Selects the Main or Sub band.	
ATT	Touch	Selects the Attenuator for the FFT scope. • 0 (OFF), 10, 20, or 30dB
	Touch for 1 second	Turns OFF the attenuator. (0 dB)
HOLD	Touch	Turns the Hold function ON or OFF. • "(HOLD)" is displayed and freezes the current audio spectrum.
LEVEL	Selects the Oscilloscope level. • 0, -10, -20, or -30 dB	
TIME	Selects the Oscilloscope sweep time. • 1, 3, 10, 30, 100, or 300 ms/Div	
SET	Displays the AUDIO SCOPE SET screen.	

Audio scope screen (Continue)

◇ **AUDIO SCOPE SET screen**

This screen is used to set the FFT scope waveform type, color, Waterfall display and oscilloscope waveform color.

1. Display the AUDIO SCOPE screen.
MENU » AUDIO
2. Touch [SET].
3. Touch to select the item to set.
 (Example: "FFT Scope Waveform Type")

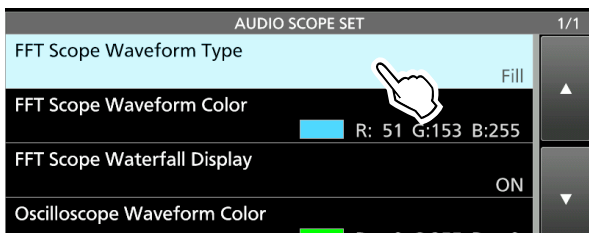

4. Touch the option to set.
 ① See the right column for details on the setting items and their options.
5. To close the AUDIO SCOPE SET screen, push EXIT.

TIP: You can set each item to its default by touching the item for 1 second, and then touching "Default" on the QUICK MENU.

FFT Scope Waveform Type (Default: Fill)

Select the type of waveform for the FFT scope.

- Line: Only the waveform outline is drawn.
- Fill: The full waveform is drawn in color.

FFT Scope Waveform Color
 (Default: (R) 51 (G) 153 (B) 255)

Set the waveform color for the FFT scope.

- ① Touch and select the R (Red), G (Green) or B (Blue) scale, and then rotate MULTI to adjust the ratio from 0 to 255.
- ① The color is displayed in the box above the RGB scale.

FFT Scope Waterfall Display (Default: ON)

Turn the Waterfall display ON or OFF.

- OFF: Turns OFF the Waterfall display.
- ON: Turns ON the Waterfall display.

Oscilloscope Waveform Color
 (Default: (R) 0 (G) 255 (B) 0)

Set the waveform color for the Oscilloscope.

- ① Touch and select the R (Red), G (Green) or B (Blue) scale, and then rotate MULTI to adjust the ratio from 0 to 255.
- ① The color is displayed in the box above the RGB scale.

SD card, SDHC card, and USB flash drive are not supplied by Icom. They are user supplied.

TIP: Icom recommends that you save the transceiver's factory default data for backup.

About the SD cards

You can use an SD card of up to 2 GB, or an SDHC of up to 32 GB. Icom has checked the compatibility with the following SD and SDHC cards.

(As of December 2017)

Brand	Type	Memory size
SanDisk®	SD	2 GB
	SDHC	4 GB
		8 GB
		16 GB
		32 GB

- ① The above list does not guarantee the card's performance.
- ① Throughout the rest of this document, the SD card and SDHC card are simply called the SD card or the card.

About the USB flash drive

Use the USB flash drive that supports the interface 1.1 or 2.0.

- ① These do not guarantee the USB flash drive's performance.

NOTE:

- Before using the SD card or USB flash drive, thoroughly read the their instructions.
- If any of the following occur, the card data or flash drive data may be corrupted or deleted.
 - You remove the card or flash drive from the transceiver while they are being accessed.
 - A power failure occurs or the power cable is disconnected while the they are being accessed.
 - You drop, impact or vibrate the card or flash drive.
- Do not touch the contacts of the card or flash drive.
- The transceiver takes a longer time to recognize a high capacity card or flash drive.
- The card or USB flash drive has a certain lifetime, so data reading or writing may not be possible after using it for a long period of time.

When reading or writing data is impossible, the card or flash drive's lifetime may have ended. In that case, use a new one.

We recommend that you make a separate backup file of the important data onto your PC.

- Icom will not be responsible for any damage caused by data corruption on a card or USB flash drive.

Saving data

You can save the following data onto the card or USB flash drive.

SD Card

- Data settings and Memory channel contents of the transceiver
- Communication log and contents
- Voice audio for the Voice TX function
- RTTY and PSK decode log
- Captured screens

USB flash drive

- Data settings and Memory channel contents of the transceiver
- Captured screens

Inserting

Insert the SD card or USB flash drive as shown below.

- ① Insert the SD card into the slot until it locks in place, and makes a 'click' sound.
- ① Be sure to check the card or flash drive orientation before inserting.

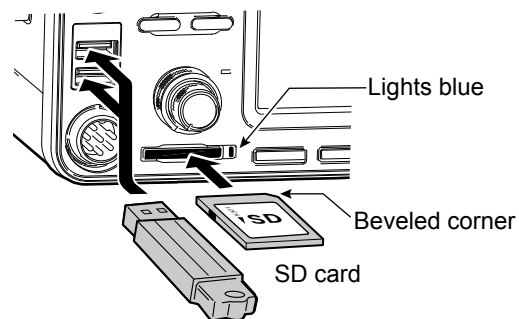

USB flash drive

- "USB" is displayed on the screen.

NOTE:

Before using an SD card or USB flash drive with the transceiver for the first time, be sure to format all SD cards or USB flash drive (p. 6-2).

- Formatting a card or flash drive erases all its data.
- Before formatting any used card or flash drive, back up its data onto your PC.
- After inserting or formatting, a special folder on the card or flash drive that you need for operations like updating the firmware are created on the card or flash drive.

IMPORTANT: Even if you have formatted an SD card, some data may remain in the card. When you dispose the card, be sure to physically destroy it to avoid unauthorized access to any data that remains.

Formatting

Before using an SD card with the transceiver, be sure to format all SD cards with the Format function. Format, even preformatted cards for PCs or other uses.

◇ Formatting the SD card or USB flash drive

1. Open the SD CARD or USB FLASH DRIVE screen.

MENU » **SET > SD Card**

MENU » **SET > USB Flash Drive**

2. Touch "Format." (Example: SD card)

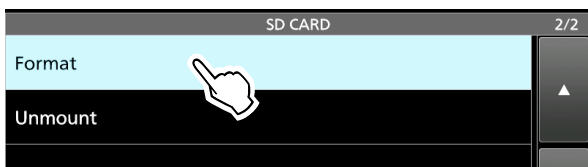

3. Touch [YES] to start formatting.

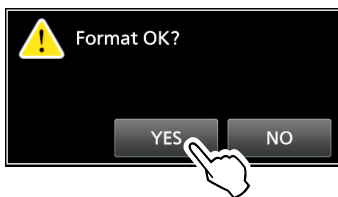

① To cancel formatting, touch [NO].
• After formatting, returns to the SD CARD set screen.

4. To close the SD CARD set screen, push **EXIT** several times.

Unmounting

Before you remove a card when the transceiver is ON, be sure to electrically unmount it, as shown below. Otherwise the data may be corrupted or deleted.

① After unmounting, SD card indicator turns OFF or "USB" disappears from the screen.

1. Open the SD CARD or USB FLASH DRIVE screen.

MENU » **SET > SD Card**

MENU » **SET > USB Flash Drive**

2. Touch "Unmount." (Example: SD card)

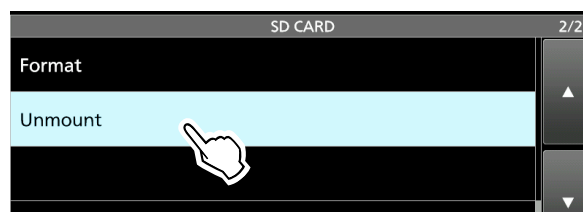

3. Touch [YES] to unmount.

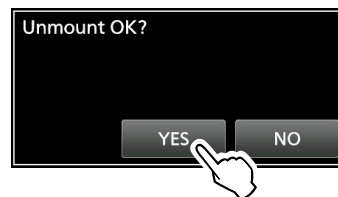

4. Remove the card from the transceiver.

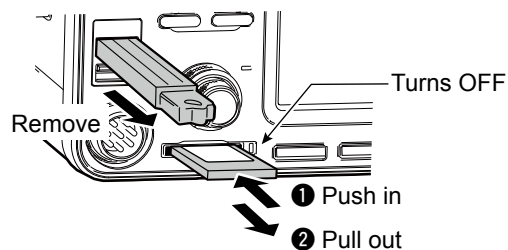

① Push in the SD card until a click sounds to unlock the card and to pull it out.

5. To close the SD CARD or USB FLASH DRIVE set screen, push **EXIT** several times.

When the transceiver is OFF

You can unmount the SD card or USB flash drive starting from step 4 of the steps described above.

About the Antenna memory settings

This function saves antenna connector settings for each frequency band. You can set antenna connectors ANT1, ANT2, ANT1/R, ANT2/R, ANT1 **R** or ANT2 **R** to selected bands.

① ANT1 is set to all frequency bands as the default.

◆ The Antenna memory screen

The Antenna memories are set on the ANTENNA screen.

MENU » **ANTENNA**

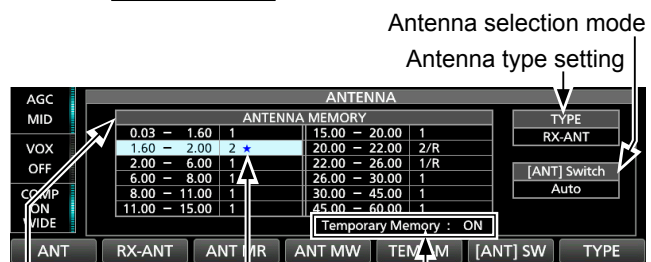

Displayed while a different antenna from the original is temporarily selected. (Example: ANT 2)

The Temporary function memory ON or OFF.

An example of antenna connector settings for each frequency band.

Key	Action
ANT	Selects [ANT1] or [ANT2]. • “★” is displayed if you temporarily select an antenna that is different from the one that is saved in the memory.
RX-ANT	Selects [ANT1/R] or [ANT2/R]. • This key is displayed when TYPE is set to “RX-ANT.” (See “Selecting the antenna type” on page 7-2)
RX/I/O	Selects [ANT1 R] or [ANT2 R]. • This key is displayed when TYPE is set to “RX-I/O.” (See “Selecting the antenna type” on page 7-2)
ANT MR	Recalls the originally saved antenna setting in the memory. • This key can be used when [[ANT] SW] is set to “Auto.”
ANT MW	Touch for 1 second Saves the current antenna connector setting in the antenna memory.
TEMP-M	Turns the Temporary memory function ON or OFF. • This function temporarily memorizes the antenna that is manually selected.
[ANT] SW	Selects the Antenna selection mode from “Auto,” “Manual” and “OFF.” • Auto: Uses the Antenna memory. • Manual: Selects each antenna connector according to the saved settings. • OFF: [ANT1] is fixed.
TYPE	Selects the antenna type to “RX-ANT” or “RX-I/O.”
TIP: When [[ANT] SW] is set to “OFF” or when in the Transverter operation, the [ANT], [RX-ANT] and [RX-I/O] keys cannot be used.	

◆ Saving an antenna connector setting

Example: Assigning ANT2 to the 10 MHz band.

1. Display the ANTENNA screen.

MENU » **ANTENNA**

2. Select the 10 MHz band.



3. Touch [ANT] and select “2 (ANT2).”

“2 ★” is displayed.

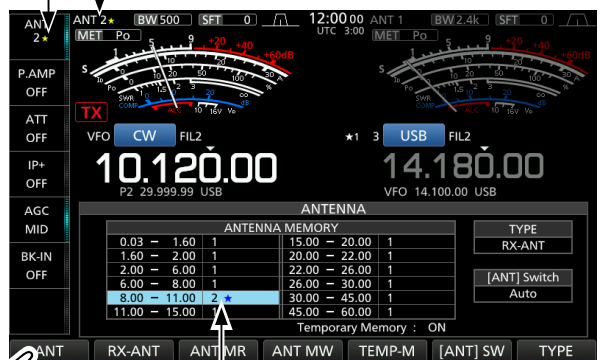

“2 ★” is displayed.

- ① You can recall the originally saved antenna setting (Example: ANT1), touch [ANT MR].

4. Touch [ANT MW] for 1 second to save “2 (ANT2)” to the 10 MHz band.

• “★” disappears.

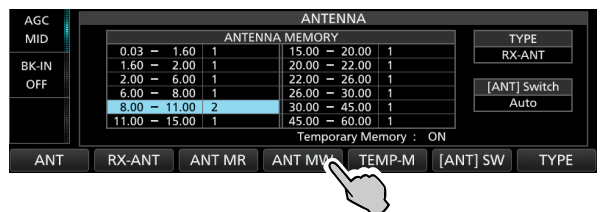

5. To close the ANTENNA screen after saving, push **EXIT**.

NOTE: Before transmitting with a selected antenna, be sure that the selected antenna suits the operating frequency by using the antenna tuner (p. 7-3). Otherwise the transceiver may be damaged.

About the Antenna memory settings (Continued)

◇ **Selecting the antenna type**

Select the antenna connecting options between “Connect Receive Antenna” (RX-ANT is displayed as the type) and “Connect External RX Device” (RX-I/O is displayed as the type.)

① “Connect Receive Antenna” is set as the default.

1. Display the ANTENNA screen.



2. Touch [TYPE].

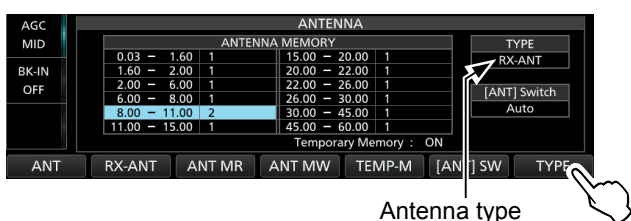

Antenna type

- The TYPE SET screen is displayed.

3. Touch “RX-ANT Connectors.”

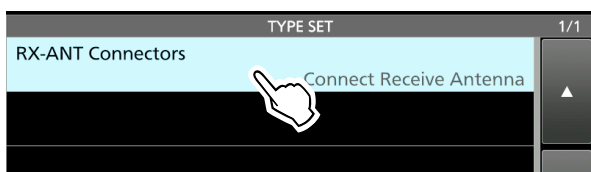

4. Select an option.
(Example: Connect External RX Device)

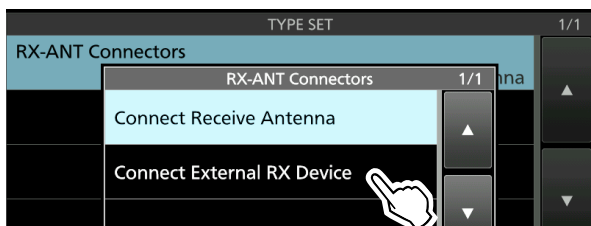

- **Connect Receive Antenna:**
Select this option to connect a receive antenna to [RX-ANT IN].
“R” is displayed next to the antenna number when [RX-ANT] is touched.
- **Connect External RX Device:**
Select this option to connect an external receive device, such as a filter or preamplifier to [RX-ANT OUT] and [RX-ANT IN].
[R] is displayed next to the antenna number when [RX-I/O] is touched.

① See the illustration in “RX-ANT IN/OUT” to the right for the connector details.

5. To close the TYPE SET screen, push [EXIT].

About the internal antenna tuner

The internal automatic antenna tuner automatically matches the transceiver to the antenna within the range of 16.7 ~ 150 Ω (SWR of less than 1:3).

After the tuner matches an antenna, the latching relay combinations are memorized as a preset point for each frequency range (100 kHz steps). Therefore, when you change the frequency range, the latching relay combinations are automatically preset to the memorized point for fast tuning.

① When you install a new antenna, or you want to change the antenna settings, you can clear the all of the internal antenna tuner preset points with the “<<Preset Memory Clear>>” item on the TUNER set screen. (p. 8-3)



NOTE: When the transceiver receives a strong physical shock, the internal latching relays may be returned to an unlatched condition. In that case, push [TUNER] to turn OFF the tuner, then turn it ON again to reset all latching relays.

Using the Internal antenna tuner

1. Push **TUNER** to turn ON the internal antenna tuner.
 - The indicator on the **TUNER** key lights.
2. Tune the antenna.
 - ① To tune the antenna, see “Manual tuning” or “PTT Tuner start” below.

◇ Manual tuning

You can manually tune the antenna before transmitting for the first time.

1. Hold down **TUNER** for 1 second to start manual tuning.
 - The tuning normally takes 2~3 seconds.
 - The indicator on the **TUNER** key blinks red.
2. After tuning, the indicator on the **TUNER** key lights white, and the internal antenna tuner stays ON.
 - ① If the tuner cannot tune, the indicator on the **TUNER** key goes out, and the tuning circuit is automatically bypassed.

◇ PTT Tuner start

The tuner is always activated when [PTT] is pushed after the frequency is changed (more than 1% from the last-tuned frequency). This function tunes the antenna for the first transmission on a new frequency.

- ① This function can be turned ON in the “PTT Start” item on the TUNER screen. (p. 8-3)

MENU » **SET > Function > Tuner > PTT Start**

NOTE:

If the SWR is higher than about 1.5:1 when tuning more than 100 kHz on an antenna's preset point, hold down **TUNER** for 1 second to start manual tuning.

If the tuner cannot tune the antenna

- Repeat manual tuning several times.
- Even if the tuner cannot tune the antenna on the first tuning, it may success at the second tuning.
- Some antennas, especially for the low bands, have a narrow bandwidth. These antennas may not tune at the edge of their bandwidth, therefore, tune such an antenna as follows:

(Example):

Suppose you have an antenna which has an SWR of 1.5:1 at 3.55 MHz and an SWR of 3:1 at 3.8 MHz.

1. Set 3.55 MHz, and hold down **TUNER** for 1 second to start manual tuning.
2. Set 3.80 MHz, and hold down **TUNER** for 1 second to start manual tuning.

About an external antenna tuner

The optional AH-4 ANTENNA TUNER matches the IC-7610 to a long wire antenna more than 7 m/23 ft long (3.5 MHz and above).

In addition, using the optional AH-2b ANTENNA ELEMENT matches the IC-7610 to a whip antenna more than 2.5 m/8.2 ft long (7 ~ 50 MHz).

The optional AH-740 AUTOMATIC TUNING ANTENNA covers 2.5 to 30 MHz range with the whip antenna that is supplied with the AH-740.

⚠ DANGER HIGH VOLTAGE!

NEVER touch the antenna element while tuning or transmitting. Always install it in a secure place.

NEVER operate the AH-4 or AH-740 without an antenna connected. The tuner and transceiver will be damaged.

◇ Using the AH-4 or AH-740

1. Turn ON the transceiver.
 - “TUNE” is displayed.
 - ① Each time you push **TUNER**, the AH-4 or AH-740 is turned ON (the indicator on the **TUNER** key lights) or OFF (bypassed).
2. Hold down **TUNER** for 1 second to start manual tuning.
 - The tuner reduces the SWR to less than 2:1 after 2~3 seconds of tuning.
 - ① While tuning, a side tone is heard and the indicator on the **TUNER** key blinks red.
 - ① If the tuner cannot reduce the SWR to less than 2:1 after 15 seconds of tuning, the indicator goes out.
3. After tuning, the indicator stops blinking and lights white.
 - ① When the long wire antenna cannot be tuned, the indicator goes out. In that case, the AH-4 is bypassed and the wire is directly connected.

NOTE: When the wire antenna cannot be tuned, check the wire length and connection.

Note that the AH-4 cannot tune a wire that is a $\frac{1}{2}\lambda$ long or on a multiple of that frequency.

About an external antenna tuner (Continued)

◇ Using an external antenna tuner

When you use a non-Icom external antenna tuner, be sure to turn OFF the internal antenna tuner before connecting it.

Otherwise, the tuning may fail because both antenna tuners (internal and external) will simultaneously start tuning.

See the antenna tuner’s instruction manual for details.

NOTE: Be sure not to connect the antenna tuner without an antenna connected. This could damage the transceiver or external antenna tuner.

TIP: If the SWR is not reduced to 2:1 after retuning, see “If the tuner cannot tune the antenna” on page 7-3 for details.

Emergency mode (Tuner)

The Emergency mode (Tuner) enables you to use the internal antenna tuner in an emergency situation, but limits the maximum output power to 50 W.

In an emergency situation, where the only antenna you have has a high SWR, you can use the antenna tuner even if the SWR is more than 3:1.

1. Display the EMERGENCY screen.

MENU » **SET > Others > Emergency**

2. Touch “Tuner.”



3. Touch [OK].



- “✓” is inserted in the Tuner check box.

4. Touch “<<Restart to SET>>” to restart the transceiver.

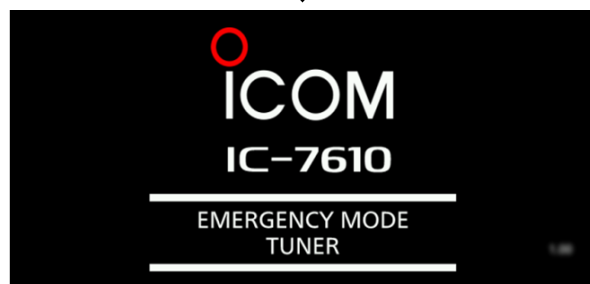

- The transceiver enters the Emergency mode (Tuner).



(E-TUN): The internal tuner is ON in the Emergency mode.

- ① While in the Emergency mode (Tuner), you cannot turn the tuner ON nor OFF by pushing **TUNER**.

TIP: To exit the Emergency mode: Touch “Tuner” again on the EMERGENCY screen to clear “✓” from the Tuner check box, and then, touch “<<Restart to SET>>” to restart the transceiver.

Set mode description

You can use the Set mode to set infrequently changed values or function settings.

TIP: The Set mode is constructed in a tree structure. You may go to the next tree level, or go back a level, depending on the selected item.

◇ Entering the Set mode

1. Push **MENU**.

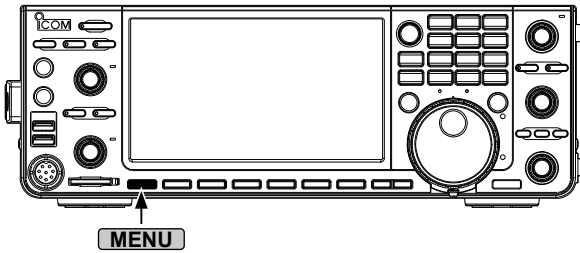

2. Touch [SET].

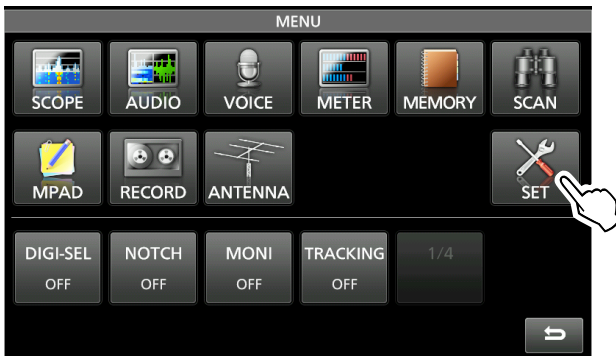

3. Touch the category that you want to select.

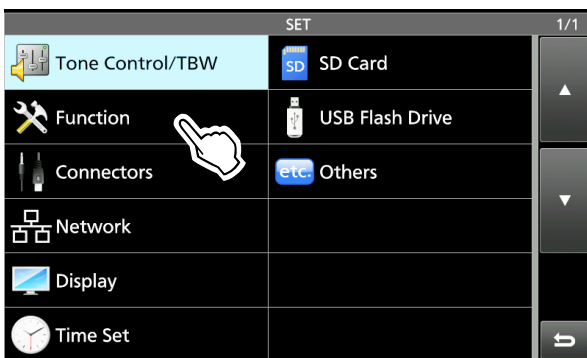

4. Push [▲] or [▼] to scroll through the items.
 Ⓜ You can also rotate **MULTI** to scroll through the items.

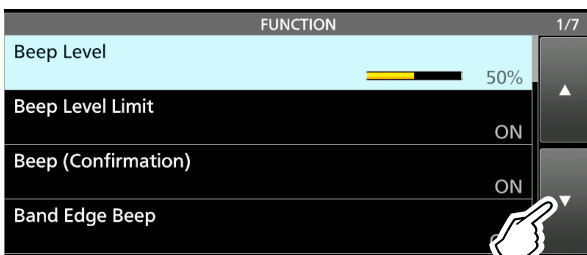

5. Touch the item to open the item's setting screen, or to open its next tree level.

Ⓜ To go back the previous tree level, push **EXIT**.

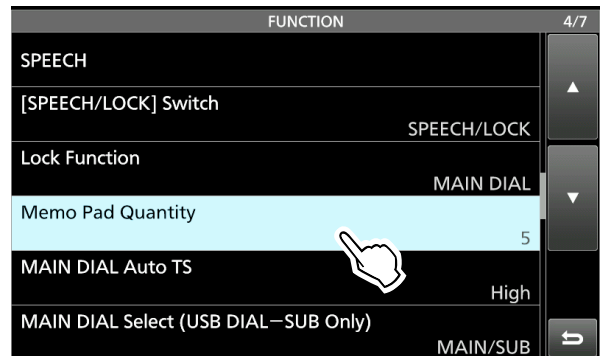

6. Touch to select or to set the option.
 • The selected option is set, and returns to the previous screen.

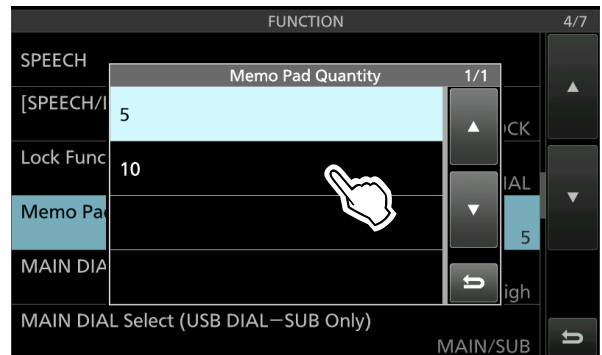

7. To close the SET screen, push **EXIT** several times.

TIP: Resetting to the default setting

1. Touch the item or its option for 1 second to display its QUICK MENU screen.
2. Touch "Default" to reset to the default setting.
 Ⓜ To close the Quick menu, push **EXIT**.

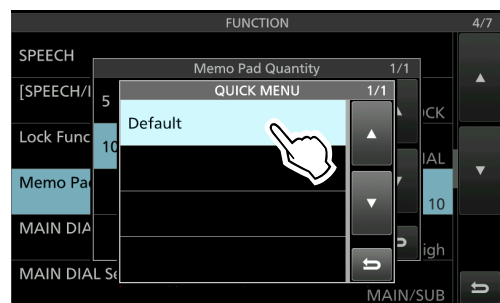

Tone Control/TBW

MENU » SET > Tone Control/TBW > RX > **SSB**

RX HPF/LPF (Default: ---- - ----)

Sets the cut-off frequencies for the receive audio high-pass filter and low-pass filter in 100 Hz steps, in the SSB mode.

① If this item is set, the “RX Bass” and “RX Treble” items are automatically set to “0.”

RX Bass (Default: 0)

RX Treble (Default: 0)

Sets the bass or treble level of the receive audio.

MENU » SET > Tone Control/TBW > RX > **AM**

RX HPF/LPF (Default: ---- - ----)

Sets the cut-off frequencies for the receive audio high-pass filter or low-pass filter in 100 Hz steps, in the AM mode.

Selectable ranges:

① If this item is set, the “RX Bass” and “RX Treble” items are automatically set to “0.”

RX Bass (Default: 0)

RX Treble (Default: 0)

Sets the bass or treble level of the receive audio.

MENU » SET > Tone Control/TBW > RX > **FM**

RX HPF/LPF (Default: ---- - ----)

Sets the cut-off frequencies for the receive audio high-pass filter or low-pass filter in 100 Hz steps, in the FM mode.

① If this item is set, the “RX Bass” and “RX Treble” items are automatically set to “0.”

FM RX Bass (Default: 0)

FM RX Treble (Default: 0)

Sets the bass or treble level of the receive audio.

MENU » SET > Tone Control/TBW > RX > **CW**

MENU » SET > Tone Control/TBW > RX > **RTTY**

MENU » SET > Tone Control/TBW > RX > **PSK**

RX HPF/LPF (Default: ---- - ----)

Sets the cut-off frequencies for the receive audio high-pass filter or low-pass filter in 100 Hz steps in the CW, RTTY, and PSK modes.

MENU » SET > Tone Control/TBW > TX > **SSB**

TX Bass (Default: 0)

TX Treble (Default: 0)

Sets the bass or treble level of the transmit audio.

TBW (WIDE) (Default: 100 – 2900)

TBW (MID) (Default: 300 – 2700)

TBW (NAR) (Default: 500 – 2500)

Sets the transmission passband width to wide, mid, or narrow, by changing the lower and higher cut-off frequencies.

MENU » SET > Tone Control/TBW > TX > **SSB-D**

TBW (Default: 300 – 2700)

Set the transmission passband width by changing the lower and upper cut-off frequencies.

MENU » SET > Tone Control/TBW > TX > **AM**

TX Bass (Default: 0)

TX Treble (Default: 0)

Sets the bass or treble level of the transmit audio.

MENU » SET > Tone Control/TBW > TX > **FM**

TX Bass (Default: 0)

TX Treble (Default: 0)

Sets the bass or treble level of the transmit audio.

Function

MENU » SET > **Function**

Beep Level (Default: 50%)

Sets the beep output level.

① If the “Beep (Confirmation)” item is set to “OFF,” no beeps sound.

Beep Level Limit (Default: ON)

Selects whether or not to limit the volume up to the specified level.

Beep (Confirmation) (Default: ON)

Turns the Confirmation beep ON or OFF.

① If the “Beep Level” item is set to “0%,” no beep sounds.

Band Edge Beep (Default: ON (Default))

Turns the Band Edge beep ON or OFF.

① Information

- If the “Beep Level” item is set to “0%,” no beep sounds.
- When you tune into an amateur band’s frequency range, the high Band Edge beep sounds.
- When you tune out of an amateur band’s frequency range, the low Band Edge beep sounds.

Beep Sound (MAIN) (Default: 1000Hz)
Beep Sound (SUB) (Default: 1000Hz)

Set the audio frequency for beeps.

RF/SQL Control (Default: RF+SQL)

Set the (AF/RF/SQL) (outer) control operation.

MENU » SET > Function > TX Delay

HF (Default: OFF)
50M (Default: OFF)

Sets the TX delay time on the HF or 50 MHz band.

- ① If an external equipment's rise time is slower than that of the IC-7610, a reflected wave is produced and it may damage the IC-7610 or the external device. To prevent this, set the appropriate delay time so that no reflected wave, or timing damage occurs.

① Select "OFF" for no rise speed.

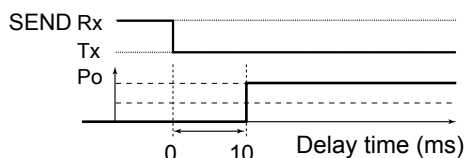

MENU » SET > Function

Time-Out Timer (CI-V) (Default: OFF)

Sets the Time-out Timer for CI-V operation. This setting is valid only transmitting initiated by a CI-V command or pushing **TRANSMIT**.

① Select "OFF" for no time limit.

Quick Dualwatch (Default: ON)

Turns the Quick Dualwatch function ON or OFF by holding down **DUAL-W** for 1 second.

MENU » SET > Function > SPLIT

Quick SPLIT (Default: ON)

Turns the Quick Split function ON or OFF by holding down **SPLIT** for 1 second.

FM SPLIT Offset (HF) (Default: -0.100 MHz)
FM SPLIT Offset (50M) (Default: -0.500 MHz)

Sets the frequency offset for the Split function in the FM mode on the HF or 50 MHz band.

SPLIT LOCK (Default: OFF)

Turns the Split Lock function ON or OFF.

MENU » SET > Function > Tuner

PTT Start (Default: OFF)

Turns the PTT Start Tuning function ON or OFF. This function starts tuning when [PTT] is pushed, if the operating frequency is shifted while the antenna tuner is ON.

<<Preset Memory Clear>>

Clears all of the internal antenna tuner's entered memory frequencies.

MENU » SET > Function

Transverter Function (Default: Auto)

Selects whether to turn ON the transverter function or to automatically turn it ON when 2 to 13.8 V DC is applied to pin 6 of [ACC 2].

Transverter Offset (Default: 16.000 MHz)

Sets the offset frequency for transverter operation.

RTTY Mark Frequency (Default: 2125)

Selects the RTTY mark frequency. ① When the internal RTTY decoder is used, 2125 Hz is automatically selected.

RTTY Shift Width (Default: 170)

Selects the RTTY shift width. ① When the internal RTTY decoder is used, 170 Hz is automatically selected.

RTTY Keying Polarity (Default: Normal)

Selects the RTTY keying polarity.

PSK Tone Frequency (Default: 1500)

Selects the PSK tone frequency for PSK reception.

MENU » SET > Function > SPEECH

SPEECH Language (Default: English)

Selects the speech language.

SPEECH Speed (Default: Fast)

Selects the speech speed.

S-Level SPEECH (Default: ON)

Turns the S-meter level announcement ON or OFF.

MODE SPEECH (Default: OFF)

Turns the operating mode announcement ON or OFF.

SPEECH Level (Default: 50%)

Sets the Voice Synthesizer audio output level.

Function (Continued)

MENU » **SET > Function**

[SPEECH/LOCK] Switch (Default: SPEECH/LOCK)

Selects **[SPEECH]** action.

Lock Function (Default: MAIN DIAL)

This function electronically locks **[MAIN DIAL]** or the panel display* to prevent accidental changes.

*Keys and dials are also locked except for **[AF/RFSQL]**, **[KEY SPEED/PITCH]**, **[POWER]**, and **[SPEECH]**.

Memo Pad Quantity (Default: 5)

Sets the number of memo pad channels.

MAIN DIAL Auto TS (Default: High)

Sets the Auto Tuning Step function for **[MAIN DIAL]**. When rapidly rotating **[MAIN DIAL]**, the tuning step automatically changes according to the rotation speed.

MAIN/SUB DIAL Select (USB DIAL–SUB Only) (Default: MAIN/SUB)

Selects whether **[MAIN DIAL]** changes only the Main band frequency, or changes both the Main and Sub band frequencies, depending on which band is selected.

① This is convenient when using the optional RC-28 REMOTE ENCODER to change the Sub band frequency.

MAIN/SUB Tracking [MAIN/SUB] Switch (Default: OFF)

Assigns the Main and Sub band tracking function to the **[MAIN/SUB]** key.

MIC Up/Down Speed (Default: Fast)

Sets the response speed of **[▲]**/**[▼]** on the supplied microphone when holding them down.

Quick RIT/ΔTX Clear (Default: OFF)

Selects the operation of **[CLEAR]** for the RIT and ΔTX functions.

[NOTCH] Switch (SSB) (Default: Auto/Manual)**[NOTCH] Switch (AM)** (Default: Auto/Manual)

Selects the notch function used in the SSB or AM mode.

FILTER Screen MAIN/SUB Select (Default: Auto (by FILTER, PBT Operation))

Selects whether or not to automatically switch the IF filter or Twin PBT settings when Main and Sub bands are switched between each other, while displaying the FILTER screen.

SSB/CW Synchronous Tuning (Default: OFF)

Turns the Displayed Frequency Shift function ON or OFF.

This function automatically shifts the frequency to match the CW pitch when the operating mode is toggled between SSB and CW.

CW Normal Side (Default: LSB)

Selects the carrier point in the CW normal mode.

Screen Keyboard Type (Default: Full Keyboard)

Sets the keyboard entry type to Ten-Key or Full Keyboard.

Screen Full Keyboard Layout (Default: English)

Select the on-screen keyboard layout between English, German and French.

Screen Capture [POWER] Switch (Default: OFF)

Assigns the Screen Capture function to **[POWER]**.

Screen Capture Keyboard [Print Screen] (Default: OFF)

Assigns the Screen Capture function to the [Print Screen] key on the USB keyboard.

Screen Capture Storage Media (Default: SD Card)

Selects the SD card or USB flash drive to save screen capture data.

Screen Capture File Type (Default: PNG)

Selects the file format for the Screen Capture function.

Calibration Marker (Default: OFF)

Turns the reference frequency calibration marker ON or OFF.

REF Adjust

Adjusts the internal reference frequency.

NOTE: The default setting of "REF Adjust" may differ slightly, depending on the transceiver's version.

Connectors

MENU » SET > Connectors > **Phones**

Level (Default: 0)

Sets the audio output level ratio of the headphone and internal speaker between -15 and +15.

L/R Mix (Default: OFF)

Selects to output the mixed audio from the headphones or to output the Main band's audio from the leftside and the Sub band's audio from the rightside.

MENU » SET > Connectors > **ACC AF/IF Output**

AF/SQL Output Select (Default: MAIN)

Selects the audio and squelch signals to output from [ACC1] (Audio: pin 5, Squelch: pin 6) in the Main and Sub bands.

Output Select (Default: AF)

Selects AF signal or IF signal to output from [ACC].

AF/IF XFC Output (SPLIT ON) (Default: MAIN)

Selects the signal output from [ACC1] while **XFC** is held down in split operation.

AF Output Level (Default: 50%)

Sets the AF output level of [ACC].

AF SQL (Default: OFF (Open))

Selects whether or not to output the audio from [ACC], according to the squelch state.

AF Beep/Speech... Output (Default: OFF)

Sets the Beep and Speech audio output setting of [ACC].

- ① You should set the "AF SQL" item to "AF."
- ① The beep level is limited when the "Beep Level Limit" item is "ON."

ACC IF Output Level (Default: 50%)

Sets the IF output level of [ACC].

MENU » SET > Connectors > **USB AF/IF Output**

Output Select (Default: AF)

Selects the signal output type from [USB1].

AF/IF XFC Output (SPLIT ON) (Default: SUB)

Selects the signal output from [USB1] while **XFC** is held down in split operation.

AF Output Level (Default: 50%)

Sets the AF output level of [USB1].

AF SQL (Default: OFF (Open))

Selects whether or not to output the audio from [USB], according to the squelch state.

AF Beep/Speech... Output (Default: OFF)

Sets the Beep and Speech audio output setting of [ACC].

- ① You should set the "AF SQL" item to "AF."
- ① The beep level is limited when the "Beep Level Limit" item is "ON."

IF Output Level (Default: 50%)

Sets the IF output level of [USB].

MENU » SET > Connectors > **LAN AF/IF Output**

Output Select (Default: AF)

Selects the signal output type from [LAN].

AF SQL (Default: ON)

Selects the squelch behavior of [LAN].

MENU » SET > Connectors > **MOD Input**

ACC MOD Level (Default: 50%)

Sets the modulation input level of [ACC].

USB MOD Level (Default: 50%)

Sets the modulation input level of [USB].

LAN MOD Level (Default: 50%)

Sets the modulation input level of [LAN].

DATA OFF MOD (Default: MIC,ACC)

Selects the connector(s) to input the modulation signal when the data mode is OFF.

Connectors (Continued)

DATA1 MOD (Default: ACC)
DATA2 MOD (Default: USB)
DATA3 MOD (Default: MIC, USB)

Selects the connector(s) to input the modulation signal when the Data mode is ON.

- ① Touching the [DATA] key in the MODE screen activates the Data mode and does the following:
- Automatically sets the modulation input to the "MIC," "ACC," "MIC, ACC," "USB," "MIC, USB" or "LAN" connector(s) selected in these items, for all three Data modes.
 - When operating in the SSB-D mode:
 - Changes the filter selection from the SSB filter set to the SSB-D. (However, you can still adjust the set receive IF filter bandwidths by touching the filter icon for 1 second.)
 - Enables the 1/4 Tuning function setting on the FUNCTION screen.
 - Disables the Speech Compressor.

MENU » SET > Connectors > **USB SEND/Keying**

USB SEND (Default: OFF)

You can control transmit and receive from the PC through the USB port. Selects the control port to be used for communication between the IC-7610 and PC.

- ① You cannot select the terminal which is already selected in the "USB Keying (CW)" or "USB Keying (RTTY)" item.

USB Keying (CW) (Default: OFF)

You can control transmit, receive and keying from the PC, through the USB port. Selects the control port to be used for communication between the IC-7610 and PC.

- ① You cannot select the terminal which is already selected in the "USB SEND" or "USB Keying (RTTY)" item.

USB Keying (RTTY) (Default: OFF)

You can control transmit, receive and RTTY (FSK) from the PC, through the USB port. Selects the control port to be used for communication between the IC-7610 and PC.

- ① You cannot select the terminal which is already selected in the "USB SEND" or "USB Keying (CW)" item.

Inhibit Timer at USB Connection (Default: ON)

Turn ON the timer to prevent unintentional SEND or Keying signal transmission if the USB driver version is not the latest one, under the following conditions.

- When connecting a PC to the IC-7610 using a USB cable.
- When a virtual serial port communication has been established.
- While the IC-7610 and a PC are connected using a USB cable, or when starting up the PC or connecting or disconnecting a USB device to or from the PC.

OFF: The IC-7610 transmits the SEND or Keying signal right after a PC or USB device is connected.

ON: The IC-7610 transmits after a few seconds have passed, to prevent unintentional transmission.

- ① If you change this setting to "OFF," update the transceiver's USB driver and make sure the SEND or Keying signal will not be unintentionally transmitted.

MENU » SET > Connectors > **External Keypad**

VOICE (Default: OFF)

Enables voice memory transmission using an external keypad.

KEYER (Default: OFF)

Enables keyer memory transmission using an external keypad.

RTTY (Default: OFF)

Enables RTTY memory transmission using an external keypad.

PSK (Default: OFF)

Enables PSK memory transmission using an external keypad.

MENU » SET > Connectors > **Keyboard/Mouse**

Keyboard [F1]-[F8] (VOICE) (Default: OFF)

Enables the Voice TX memory transmission using a keyboard connected to [USB].

Keyboard [F1]-[F8] (KEYER) (Default: OFF)

Enables keyer memory transmission using a keyboard connected to [USB].

Keyboard Type (Default: English)

Selects the keyboard language.

Keyboard Repeat Delay (Default: 250ms)

Sets the repeat delay time of the keyboard.

Keyboard Repeat Rate (Default: 10.9cps)

Sets the repeat rate of the keyboard.

Mouse Pointer Speed (Default: MID)

Selects the mouse pointer speed.

Mouse Pointer Acceleration (Default: ON)

Turns the mouse pointer acceleration ON or OFF.

MENU » SET > Connectors > **USB DIAL**

USB DIAL Select (Default: SUB Only)

Selects the Sub band or Main and Sub band to operate on the RC-28's main dial.

USB DIAL Auto TS (Default: High)

Selects the Automatic Tuning Step for the RC-28's main dial.

When rapidly rotating the RC-28's main dial, the tuning step is automatically changed according to the rotation speed.

USB DIAL [TRANSMIT] Switch

(Default: Push to toggle)

Selects whether to toggle between transmit and receive by pushing, or to transmit only while holding the [TRANSMIT] key on the RC-28.

MENU » **SET > Connectors > CI-V**

CI-V Baud Rate (Default: Auto)

Selects the CI-V data transfer rate.
 ①When “Auto” is selected, the baud rate is automatically set according to the data rate of the connected device.

CI-V Address (Default: 98)

Sets the CI-V address.
 ①“98h” is the default address of the IC-7610.

CI-V Transceive (Default: ON)

Turns the Transceive function ON or OFF.

CI-V USB/LAN→REMOTE Transceive Address (Default: 00)

Sets the address used to remotely control the transceiver or receiver using the optional RS-BA1, through the [USB] port.
 The external equipment control signal is output from the [REMOTE] port.

CI-V Output (for ANT) (Default: OFF)

Enables outputting the antenna controller status (frequency and so on) from the [REMOTE] port.
 ①Address “01h” is reserved.
 The usable addresses are limited to 02h ~ DFh.

CI-V USB Port (Default: Unlink from [REMOTE])

Selects the internal connection type between the [USB] and [REMOTE] CI-V ports.

CI-V USB Baud Rate (Default: Auto)

Selects the CI-V data transfer rate when remotely controlling the IC-7610 through the [USB] CI-V port.
 ①When “Auto” is selected, the baud rate is automatically set according to the data rate of external device.
 ①This setting is valid only when the “CI-V USB Port” item is set to “Unlink from [REMOTE].”

CI-V USB Echo Back (Default: OFF)

Turns the Data Echo Back function ON or OFF, when remotely controlling the IC-7610 through the [USB] CI-V port.
 ①This setting is valid only when the “CI-V USB Port” item is set to “Unlink from [REMOTE].”

MENU » **SET > Connectors > External Meter**

External Meter Output (MAIN) (Default: Auto)
External Meter Output (SUB) (Default: Auto)

Selects the parameter (Main and Sub readout) to output to an external meter.

External Meter Level (MAIN) (Default: 50%)
External Meter Level (SUB) (Default: 50%)

Sets the output level to the external meter (Main and Sub band).

MENU » **SET > Connectors**

Decode Baud Rate (Default: 9600)

Selects the data transfer rate (Baud rate) of decoded signals.

SEND Relay Type (Default: MOS-FET)

Selects the switching relay type for [RELAY].
 Select the suitable relay type, especially when connecting a non-Icom linear amplifier.

ACC BAND Voltage Output (Default: TX)

Selects the operating band voltage output from [ACC2] (pin 4).

MIC Input DC Bias (Default: ON)

Outputs the 8 V bias voltage (approximate) from the microphone connector (pin 1 of [MIC]).

REF IN (Default: OFF)

Selects the transceiver’s reference frequency signal source.
 ①This setting will be valid after restarting the transceiver.
 ①If the applied reference signal is off frequency, or not high enough, the IC-7610 will not work correctly. In that case, select “OFF,” and then restart the IC-7610.

Network

MENU » **SET > Network**

DHCP (Default: ON(. . .))

Turns the DHCP function ON or OFF.

IP Address (Default: 192.168. 0. 10)

Sets the static IP address.

Subnet Mask (Default: 255.255.255. 0 (24 bit))

Sets the subnet mask to connect to your PC or LAN (Local Area Network), through the Ethernet.

Default Gateway (Default: —)

If you are operating the IC-7610 using the optional RS-BA1, a default gateway setting is required.

Network (Continued)

Primary DNS Server (Default: —)

If there are two DNS server addresses, enter the primary DNS server address.

2nd DNS Server (Default: —)

If there are two DNS server addresses, enter the secondary DNS server address.

Network Name (Default: —)

If you are operating the IC-7610 using the optional RS-BA1, enter a network name of up to 15 characters.

Network Control (Default: OFF)

If you are operating the IC-7610 using the optional RS-BA1, select "ON."

Power OFF Setting (for Remote Control) (Default: Shutdown only)

Selects whether to shutdown or to enter the remote standby mode after the transceiver is turned OFF.

Control Port (UDP) (Default: 50001)

If you are operating the IC-7610 using the optional RS-BA1 software, set a port number for the control signal between the IC-7610 and the remote station.

Serial Port (UDP) (Default: 50002)

If you are operating the IC-7610 using the optional RS-BA1 software, set a port number for the serial data between the IC-7610 and the remote station.

Audio Port (UDP) (Default: 50003)

If you are operating the IC-7610 using the optional RS-BA1 software, set a port number for the audio signal between the IC-7610 and the remote station.

Internet Access Line (Default: FTTH)

If you are operating the IC-7610 using the optional RS-BA1 software, set the port number for the audio signal between the IC-7610 and the remote station.

MENU » SET > Network > **Network User1**

MENU » SET > Network > **Network User2**

Network User1 ID (Default: —)

Network User2 ID (Default: —)

If you are operating the IC-7610 using the optional RS-BA1, enter a user name of up to 16 characters.

Network User1 Password (Default: —)

Network User2 Password (Default: —)

Enter a password for each user.

Network User1 ID Administrator (Default: NO)

Network User1 ID Administrator (Default: NO)

Sets the user as the administrator. Only the authorized user can disconnect the communication between the IC-7610 and the remote station.

MENU » SET > **Network**

Network Radio Name (Default: IC-7610)

If you are operating the IC-7610 using the optional RS-BA1 software, enter a name of up to 15 characters.

Display

MENU » SET > **Display**

LCD Backlight (Default: 50%)

Sets the LCD backlight brightness.

LED Bright (Default: 50%)

Sets the LED brightness.

Display Type (Default: A)

Sets the display type to A or B.

Display Font (Default: Basic)

Selects the font for the frequency readout.

Meter Response (Standard, Edgewise) (Default: Mid)

Sets the meter needle response speed to Slow, Mid or Fast.

Meter Type (Normal Screen) (Default: Standard)

Sets the S/Rf meter type for the normal display to Standard, Edgewise or Bar.

Meter Type (Expand Screen) (Default: Bar)

Sets the S/Rf meter type for the expanded display to Standard, Edgewise or Bar.

Meter Peak Hold (Bar) (Default: ON)

Turns the Meter Peak Hold function ON or OFF.

Memory Name (Default: ON)

Turns the Memory name display in the Memory mode ON or OFF.

APF-Width Popup (APF OFF→ON) (Default: ON)

Turns the APF filter width display ON or OFF.

Screen Saver (Default: 60min)

Sets the Screen Saver function. This function activates and automatically turns OFF the screen when no operation is performed for the preset period of time.

External Display (Default: OFF)

Select "ON" when using an external display.

External Display Resolution (Default: 800x480)

Select the screen resolution of the external display.

Opening Message (Default: ON)

Selects whether or not to display the opening message at power ON.

My Call (Default: —)

Displays text as the opening message, up to 10 characters.

Power ON Check (Default: ON)

Selects whether or not to display the RF Power level at power ON.

Display Language (Default: English)

Sets the display language.

Time Set

MENU » SET > Time Set > **Date/Time**

Date

Sets the date (Year/Month/Day). (The day of the week is automatically set.)

Time

Sets the current time. (The time is displayed in the 24 hour format.)

NOTE: The backup battery for the internal clock

The IC-7610 has a rechargeable Lithium battery to backup the internal clock. If you connect the transceiver to a power source, the battery is charged and it keeps the correct clock setting. However, if you do not connect the transceiver to a power source for a long period of time, the battery will discharge. In that case, the transceiver resets the internal clock.

If you do not use the transceiver for a long period of time, we recommend that you connect the transceiver to a power source at least once a month. The charging period is two days whether the transceiver's power is ON or OFF.

<<NTP TIME SYNC>>

Synchronizes the internal clock with the time management server.

① To use this function, you need an Internet connection and default gateway settings.

NTP Function (Default: ON)

Automatically obtains the current time from the NTP server.

NTP Server Address (Default: time.nist.gov)

Sets NTP server address.

MENU » SET > Time Set

UTC Offset (Default: ± 0:00)

Sets the UTC offset time.

CLOCK2 Function (Default: ON)

Displays the second clock on the screen.

CLOCK2 UTC Offset (Default: ± 0:00)

Sets the time offset for Clock 2.

CLOCK2 Name (Default: UTC)

Sets the name of up to 3 characters for Clock 2.

SD Card

MENU » SET > SD Card

Load Setting

Selects the saved data file to load.

Save Setting

Saves the setting data onto an SD card.

Save Form (Default: Now Ver)

Selects the format to save the settings to an SD card.

Now Ver: Saves the settings in the current version format.

Old Ver (x.xx - x.xx): Saves the settings in the older version format indicated in the parenthesis (x.xx = version).

① If you select "Old Ver (x.xx - x.xx)," a function that is added when the transceiver's firmware format is updated will not be saved.

① You cannot load a setting file that is saved in the current version format to an earlier firmware version.

SD Card Info

Displays the SD card capacity and the time remaining for voice recording.

Screen Capture View

Displays the selected screen capture.

Firmware Update

Displays the Firmware Update mode.

SD Card (Continued)

Format

Formats the SD card.

If you use a brand new SD card, be sure to format it in the transceiver.

Unmount

Unmounts the SD card.

Before you remove a card when the transceiver is ON, be sure to electrically unmount it. Otherwise the data may be corrupted or deleted.

USB Flash Drive

MENU » SET > USB Flash Drive

Load Setting

Selects the saved data file to load.

Save Setting

Saves the setting data onto a USB flash drive.

Save Form (Default: Now Ver)

Selects the format to save the settings to an SD card.

Now Ver: Saves the settings in the current version format.

Old Ver (x.xx - x.xx): Saves the settings in the older version format indicated in the parenthesis (x.xx = version).

① If you select "Old Ver (x.xx - x.xx)," a function that is added when the transceiver's firmware format is updated will not be saved.

① You cannot load a setting file that is saved in the current version format to an earlier firmware version.

USB Flash Drive Info

Displays the USB flash drive capacity and the time remaining for voice recording.

Screen Capture View

Displays the selected screen capture.

Firmware Update

Displays the Firmware Update mode.

Format

Formats the USB flash drive.

If you use a brand new USB flash drive, be sure to format it in the transceiver.

Unmount

Unmounts the USB flash drive.

Before you remove a flash drive when the transceiver is ON, be sure to electrically unmount it. Otherwise the data may be corrupted or deleted.

Others

MENU » SET > Others > Information

Version

Displays the transceiver firmware's version number.

MAC Address

Displays the transceiver's MAC address.

MENU » SET > Others

Touch Screen Calibration

Touch to adjust the touch screen.

① See the *Advanced Manual* for details.

MENU » SET > Others > Reset

Partial Reset

Resets operating settings to their default values (VFO frequency, VFO settings, menu contents) without clearing the items below:

- Memory channel contents
- MY Call
- Memory Keyer
- RTTY memory
- User Band Edge
- REF Adjust
- Fixed Edges

① See "Resetting" (p.10-1) for details.

All Reset

Clears all data and returns all settings to their factory defaults.

Memory channel contents, filter setting and so on will all be cleared, so you will need to rewrite your operating settings.

① See "Resetting" (p. 10-1) for details.

MENU » SET > Others > Emergency

Emergency

Enters the Emergency mode by touching "Tuner."

① See page 7-4 for details.

Setting the date and time

◇ Setting the date

1. Display the DATE/TIME screen.

MENU » **SET > Time Set > Date/Time**

2. Touch “Date.”
 - Displays the date editing screen.
3. Touch [+] or [-] to set the date.

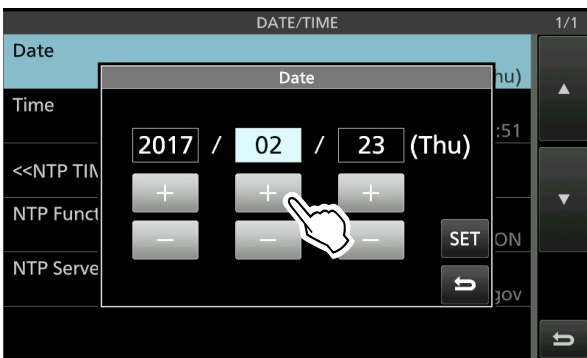

4. Touch [SET] to set the date.
 - Returns to the previous screen.
- ① To cancel the editing, touch [↩].

◇ Setting the current time

1. Display the DATE/TIME screen.

MENU » **SET > Time Set > Date/Time**

2. Touch “Time.”
 - Displays the time editing screen.
3. Touch [+] or [-] to set the current time.

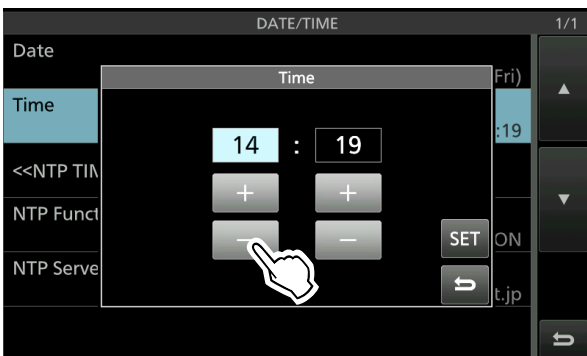

4. Touch [SET] to set the time.
 - Returns to the previous screen.
- ① To cancel the editing, touch [↩].

◇ Setting the UTC offset

1. Display the TIME SET screen.

MENU » **SET > Time Set**

2. Touch “UTC Offset.”
 - Displays the UTC offset editing screen.
3. Touch [+] or [-] to set the UTC offset.



4. Touch [↩] to set the UTC offset.
 - Returns to the previous screen.

TIP: UTC time is displayed under the current time display on the operating screen, only when the “CLOCK2 Function” item is set to ON (default).

◇ Displaying CLOCK2

You can display a different time, such as UTC, or other location. This is convenient when you make QSOs with non-local time stations.

Set the CLOCK2 function ON to display the time on the operating screen. (Default: ON)

1. Display the TIME SET screen.

MENU » **SET > Time Set**

2. Touch “CLOCK2 Function.”
3. Touch ON or OFF.
 - ON: CLOCK2’s time is displayed under the current time.
 - OFF: CLOCK2’s time is not displayed.

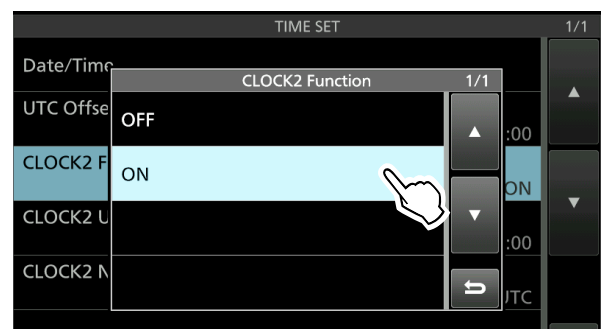

4. Touch [↩] to set the CLOCK2 function.
 - Returns to the previous screen.

Setting the date and time (Continued)

◇ **Setting the CLOCK2 UTC offset**

Set the time offset for CLOCK2 the same as for the current time.

1. Display the TIME SET screen.
MENU » **SET > Time Set**
2. Touch “CLOCK2 UTC Offset.”
 • Displays the CLOCK2 UTC offset editing screen.
3. Touch [+] or [-] to set the UTC offset.



4. Touch **=>** to set the UTC offset.
 • Returns to the previous screen.

◇ **Editing the CLOCK2 name**

You can edit CLOCK2's 3 character name. The default name is “UTC.”

1. Display the TIME SET screen.
MENU » **SET > Time Set**
2. Touch “CLOCK2 Name.”
 • Displays the name editing screen for CLOCK2.
3. First, touch [CLR] several times to clear the default name, and then enter the name.
 ① See “Keyboard entering and editing” (p. 1-8) for details.
4. Touch [ENT] to set the name.
 • Returns to the previous screen.



TIP: CLOCK2's time and name are displayed under the current time, only when the “CLOCK2 Function” item is set to ON (default).

Resetting

Occasionally, erroneous information may be displayed. This may be caused by static electricity or by other factors.

If this problem occurs, turn OFF the transceiver. After waiting a few seconds, turn ON the transceiver again. If the problem still exists, perform a **Partial reset**, as described to the right.

If the problem still exists after a Partial reset, perform an **All reset**, as described to the right.

NOTE: An All reset clears all data and returns all settings to their factory defaults. Save memory channel content, setting status, and so on, onto an SD card before an All reset. (p. 10-1)

After performing a Partial reset

A Partial reset resets operating settings to their default values (VFO frequency, VFO settings, menu contents) without clearing the items listed below:

- Memory channel contents
- Fixed Edges on the Spectrum Scope
- Network settings in the set mode
- MY Call
- REF Adjust

After performing an All reset

All reset clears all data and returns all settings to their factory defaults.

Memory channel contents, filter setting and so on will all be cleared, so you will need to rewrite your operating settings, unless you have a backup.

When you cannot enter the Set mode

If a touch screen operation error or an unexpected operation occurs, you cannot enter the Set mode. In this case, perform an All reset, as described below:

While holding down **MAIN/SUB** and **CHANGE**, push **POWER**.

◇ Partial reset

1. Open the RESET screen.

MENU » **SET > Others > Reset**

2. Touch “Partial Reset.”



- The confirmation screen is displayed.

3. Touch [Yes].

① After the resetting, the default VFO mode screen is displayed.



◇ All reset

1. Open the RESET screen.

MENU » **SET > Others > Reset**

2. Touch “All Reset.”

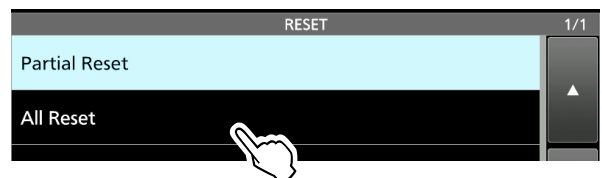

- The confirmation screen is displayed.

3. Touch [NEXT].

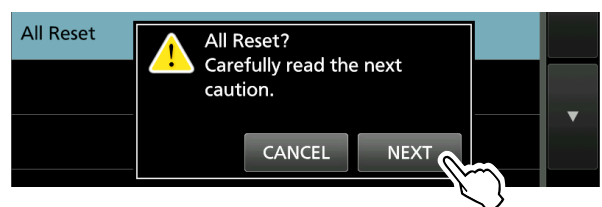

4. After carefully reading the displayed message, touch [YES] to perform the All reset.

① After the resetting, the default VFO mode screen is displayed.

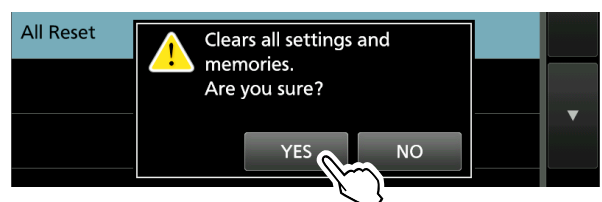

Troubleshooting

The following chart is designed to help you solve problems that are not equipment malfunctions.

If you are unable to locate the cause of a problem, or solve it through the use of this chart, contact your nearest Icom Dealer or Service Center.

PROBLEM	POSSIBLE CAUSE	SOLUTION	REF.
Power does not turn ON when POWER is pushed.	The power cable is not connected properly.	Reconnect the DC power cable properly.	p. 2-1
	The external power supply is turned OFF.	Turn ON the external power supply.	p. 2-1
	The DC power cable fuses or circuitry fuse are blown.	Find and repair the cause of the problem, and then replace the damaged fuse with a new one.	–
No sound is heard from the speaker.	The audio level is too low.	Rotate AF↔RF/SQL (inner) clockwise to obtain a suitable listening level.	p. 3-1
	The squelch is closed.	Rotate AF↔RF/SQL (outer) to the 12 o'clock position to open the squelch.	p. 3-7
	If no sound is heard only from the Sub band, the Dualwatch function is OFF.	Turn ON the Dualwatch function.	p. 3-2
	Headphones are connected.	Disconnect the headphones.	p. 13-1
	The Mute function is ON.	Push AF↔RF/SQL to turn OFF the Mute function on whichever band is selected (Main or Sub).	p. 1-1
	The external speaker cable is defective.	Check the external speaker cable and repair it.	–
Sensitivity is too low, and only strong signals are heard.	The attenuator is activated.	Turn OFF the attenuator in the Multi-function key group.	p. 4-1
	The squelch is closed.	Rotate AF↔RF/SQL (outer) to 12 o'clock position to open the squelch.	p. 3-7
	The antenna is defective or the coaxial cable is defective.	Repair the problem and then reconnect the antenna.	p. 2-2
	You are using an antenna that is not suitable for the band you have selected.	Connect an antenna suitable for the operating frequency.	p. 2-2
		Hold down TUNER to tune the antenna.	p. 7-2
No power output or the output power is too low.	The operating frequency is outside the ham band.	Set the frequency to a ham band.	p. 3-4
	The modulation input signal level is set too low.	Adjust the microphone gain in MIC GAIN.	p. 3-9
	The microphone is bad, or the [MIC] connector is shorted or defective.	Test the microphone and check the [MIC] connector.	p. 13-3
	The antenna SWR is more than 3:1.	Adjust the antenna for an SWR of less than 3:1.	p. 7-3
	The antenna is not properly tuned.	Hold down TUNER for 1 second to tune the antenna.	p. 7-3
	The transmit output power is set too low.	Adjust the RF POWER in the Multi-function menu.	p. 3-8

Troubleshooting (Continued)

PROBLEM	POSSIBLE CAUSE	SOLUTION	REF.
The transceiver automatically switches to transmit while receiving.	The VOX function is ON.	Turn OFF the VOX function in the Multi-function menu.	p. 1-6
	The VOX gain is set too high.	Adjust the VOX gain.	p. 1-6
Cannot contact with another station, even if receiving and transmitting seem normal.	The Split function is activated. (The transmit and receive frequencies are different.)	Push [SPLIT] to turn OFF the Split function.	p. 4-9
	The RIT function or the ΔTX function is ON, and a different receive or transmit frequency is set.	Push [RIT] or [ΔTX] to turn OFF the function.	p. 4-1 –
Received audio in the SSB mode is unclear or distorted.	The incorrect sideband is selected.	Toggle between USB and LSB.	p. 3-3
	The PBT function is activated.	Rotate (TWIN PBT CLR) to clear the settings.	p. 4-3
Transmit signal is unclear or distorted in the SSB mode.	The transceiver's microphone gain is too high.	Adjust the MIC GAIN level so that the meter reading swings between 30 and 50% of the ALC scale.	p. 3-9
	The desktop microphone gain is too high.		
The operating frequency is not properly changed by rotating (MAIN DIAL) .	The Dial Lock function is activated.	Hold down [SPEECH CLR] to turn the Dial Lock function OFF.	p. 3-6
Programmed scan does not start.	The same frequencies have been set in scan edge memory channels P1 and P2.	Set different frequencies in scan edge memory channels P1 and P2.	–
Memory scan does not start.	No, or only 1 memory channel is set.	Set at least 2 memory channels.	p. 3-6
Select memory scan does not start.	No, or only 1 memory channel is designated as a Select channel.	Designate at least 2 memory channels as Select channels for the scan.	–
The contents of a selected memory channel is not changed.	The contents of the selected memory channel were changed, but they are not saved.	When you want to save the changed settings, touch [MW] for 1 second to write them into the memory channel on the VFO/MEMORY screen.	–
Cannot hear the speech after pushing [SPEECH CLR] .	The speech level is too low.	Adjust "SPEECH Level" in the Speech setting.	p. 8-3
The antenna SWR is too high.	The antenna is not properly tuned.	Adjust the antenna SWR. The antenna SWR should be less than 3.	p. 7-3
	The coaxial cable is not suitable.	Use a coaxial cable whose characteristic impedance is 50 Ω.	p. 12-1
"OVF" is displayed.	An excessively strong signal is received.	Rotate (AF RF/SQL) (outer) counter clockwise.	p. 3-7
		Turn ON the attenuator.	p. 4-1
		Turn OFF the Preamp (P.AMP OFF).	p. 4-1
		Turn ON the Digital Selector function.	p. 4-6
The touch screen is not working correctly.	The touched point and the detected point may be different.	Calibrate the touch screen in the OTHERS screen.	p. 8-10

◇ General

- Frequency coverage (unit: MHz):

Receiver	0.030000 ~ 60.000000
Transmitter	0.135700 ~ 0.137800 (Only in the European version)
	1.800000 ~ 1.999999*
	3.500000 ~ 3.999999*
	5.255000 ~ 5.405000 (Only in the USA version)
	7.000000 ~ 7.300000*
	10.100000 ~ 10.150000
	14.000000 ~ 14.350000
	18.068000 ~ 18.168000
	21.000000 ~ 21.450000
	24.890000 ~ 24.990000
	28.000000 ~ 29.700000
	50.000000 ~ 54.000000*

*The frequency coverage and guaranteed ranges differ, depending on the transceiver version.
- Operating modes: USB/LSB (J3E), CW (A1A), RTTY (F1B), PSK (G1B), AM (A3E) and FM (F3E)
- Number of memory channels: 101 (including 2 scan edges)
- Antenna connectors: SO-239×2 (antenna impedance: 50 Ω Unbalanced)
- Power supply requirement: 13.8 V DC (±15%)
- Operating temperature range: 0°C to +50°C, +32°F to +122°F
- Frequency stability: Less than ±0.5 ppm (0°C to +50°C, +32°F to +122°F)
- Frequency resolution: 1 Hz (minimum)
- Power consumption:

Receive	Standby	3.0 A
	Maximum audio	3.5 A
Transmit	Maximum power	23.0 A
- Dimensions (projections not included): 340 (W) × 118 (H) × 277 (D) mm, 13.4 (W) × 4.6 (H) × 10.9 (D) in
- Weight (approximate): 8.5 kg, 18.7 lb

◇ Transmitter

- Transmit output power:

HF and 50 MHz bands	
SSB/CW/RTTY/PSK/FM	1~100 W
AM	1~25 W
- Modulation system:

SSB	P.S.N. modulation
AM	Low power modulation
FM	Reactance modulation
- Spurious emission:

Harmonics	Less than -50 dB (HF band)
	Less than -63 dB (50 MHz band)
Out-of-band emission	Less than -40 dB (HF band)
	Less than -60 dB (50 MHz band)
- Carrier suppression: More than 50 dB
- Unwanted sideband suppression: More than 50 dB
- Microphone impedance: 600 Ω

◇ Receiver

- Receive system: Direct sampling superheterodyne
- Intermediate frequency: 12 kHz
- Sensitivity (Filter: SOFT):
 - SSB/CW (at 10 dB S/N)
 - 1.8 ~ 29.999999 MHz –16 dB μ V (0.16 μ V) typical (P.AMP1 ON)
 - 50 MHz band –18 dB μ V (0.13 μ V) typical (P.AMP2 ON)
 - AM (at 10 dB S/N)
 - 0.1 ~ 1.799999 MHz +16 dB μ V (6.3 μ V) typical (P.AMP1 ON)
 - 1.8 ~ 29.999999 MHz +6 dB μ V (2.0 μ V) typical (P.AMP1 ON)
 - 50 MHz band 0 dB μ V (1.0 μ V) typical (P.AMP2 ON)
 - FM (at 12 dB SINAD)
 - 28.0 ~ 29.7 MHz –6 dB μ V (0.5 μ V) typical (P.AMP1 ON)
 - 50 MHz band –10 dB μ V (0.32 μ V) typical (P.AMP2 ON)
- Sensitivity for the European version (Filter: SOFT):
 - SSB (BW=2.4 kHz, 12 dB SINAD)
 - 1.8 ~ 2.999999 MHz Less than 10 dB μ V emf (P.AMP 1 ON)
 - 3.0 ~ 29.999999 MHz Less than 0 dB μ V emf (P.AMP 1 ON)
 - 50 MHz band Less than –6 dB μ V emf (P.AMP 2 ON)
 - AM (BW=4 kHz, 60% Modulation, 12 dB SINAD)
 - 1.8 ~ 2.999999 MHz Less than 16 dB μ V emf (P.AMP 1 ON)
 - 3.0 ~ 29.999999 MHz Less than 6 dB μ V emf (P.AMP 1 ON)
 - 50 MHz band Less than 0 dB μ V emf (P.AMP 2 ON)
 - FM (BW=7 kHz, 60% Modulation, 12 dB SINAD)
 - 28.0 ~ 29.7 MHz Less than 0 dB μ V emf (P.AMP 1 ON)
 - 50 MHz band Less than –6 dB μ V emf (P.AMP 2 ON)
- Squelch sensitivity (threshold):
 - SSB Less than +10 dB μ V (3.2 μ V)
 - FM Less than –10 dB μ V (0.32 μ V)
 (HF band: P.AMP1 ON, 50 MHz band: P.AMP2 ON)
- Selectivity (Filter: SHARP):
 - SSB (BW=2.4 kHz)
 - More than 2.4 kHz/–6 dB
 - Less than 3.6 kHz/–60 dB
 - CW (BW=500 Hz)
 - More than 500 Hz/–6 dB
 - Less than 700 Hz/–60 dB
 - RTTY (BW=500 Hz)
 - More than 500 Hz/–6 dB
 - Less than 700 Hz/–60 dB
 - AM (BW=6 kHz)
 - More than 6.0 kHz/–6 dB
 - Less than 15 kHz/–60 dB
 - FM (BW=15 kHz)
 - More than 12.0 kHz/–6 dB
 - Less than 20 kHz/–60 dB
- Spurious and image rejection: More than 70 dB (except for ADC aliasing)
- Audio output power: More than 2.0 W (8 Ω load, 1 kHz, 10% distortion)
- AF output impedance: 8 Ω
- RIT variable range: \pm 9.999 kHz

◇ Antenna tuner

- Tunable impedance range: 16.7~150 Ω (unbalanced) (less than 1:3 VSWR)
- Tuning accuracy: Less than 1:1.5 VSWR
- Tuning time (approximate):
 - 2~3 seconds (average)
 - 15 seconds (maximum)

①All stated specifications are typical and subject to change without notice or obligation.

Options

IC-PW1/IC-PW1EURO LINEAR AMPLIFIER

HF/50 MHz all band 1 kW linear amplifier including an automatic antenna tuner. An optional OPC-599 ADAPTER CABLE is required for the connection.



AH-2b

ANTENNA ELEMENT

A 2.5 m (8.2 ft) long antenna element for mobile operation with the AH-4.



AH-4 ANTENNA TUNER

Automatic antenna tuner to tune a long wire or whip antenna for base, portable, or mobile HF/50 MHz operation.



AH-740 AUTOMATIC TUNING ANTENNA

High performance, automatic high-speed tuning antenna.

The optional AH-5NV NVIS KIT is available.



HM-219 MICROPHONE



PS-126 DC POWER SUPPLY

- Output voltage: 13.8 V DC
- Maximum output current: 25 A



RC-28 REMOTE ENCODER

For operating the RS-BA1 (version 1.3 or later) or using as a sub dial to operate the transceiver.



SM-50

DESKTOP MICROPHONE

Dynamic microphone with [UP]/[DOWN] switches.



SM-30

DESKTOP MICROPHONE

Desktop microphone with a low frequency cut function.



SP-23

EXTERNAL SPEAKER

External speaker with high and low frequency cut functions. (2 W/8 Ω)



SP-34

EXTERNAL SPEAKER

External speaker with high and low frequency cut functions. (3 W/8 Ω)



- **AH-5NV** NVIS KIT
Use with the AH-740.
- **AH-710** FOLDED DIPOLE ANTENNA
Covers 2 to 30 MHz wide frequency range.
Element length: 24.5 m (80.4 ft)
Coaxial cable (supplied): 30 m (98.4 ft)
- **MB-121** CARRYING HANDLE
- **OPC-420** CONTROL CABLE
A 10 m (32.8 ft) shielded control cable for the AH-4.

- **RS-BA1** IP REMOTE CONTROL SOFTWARE

NOTE: To remotely control transceivers using the RS-BA1, BE SURE to comply with your local regulations.

- **SP-33** EXTERNAL SPEAKER
Designed for base station operation.

Interface information

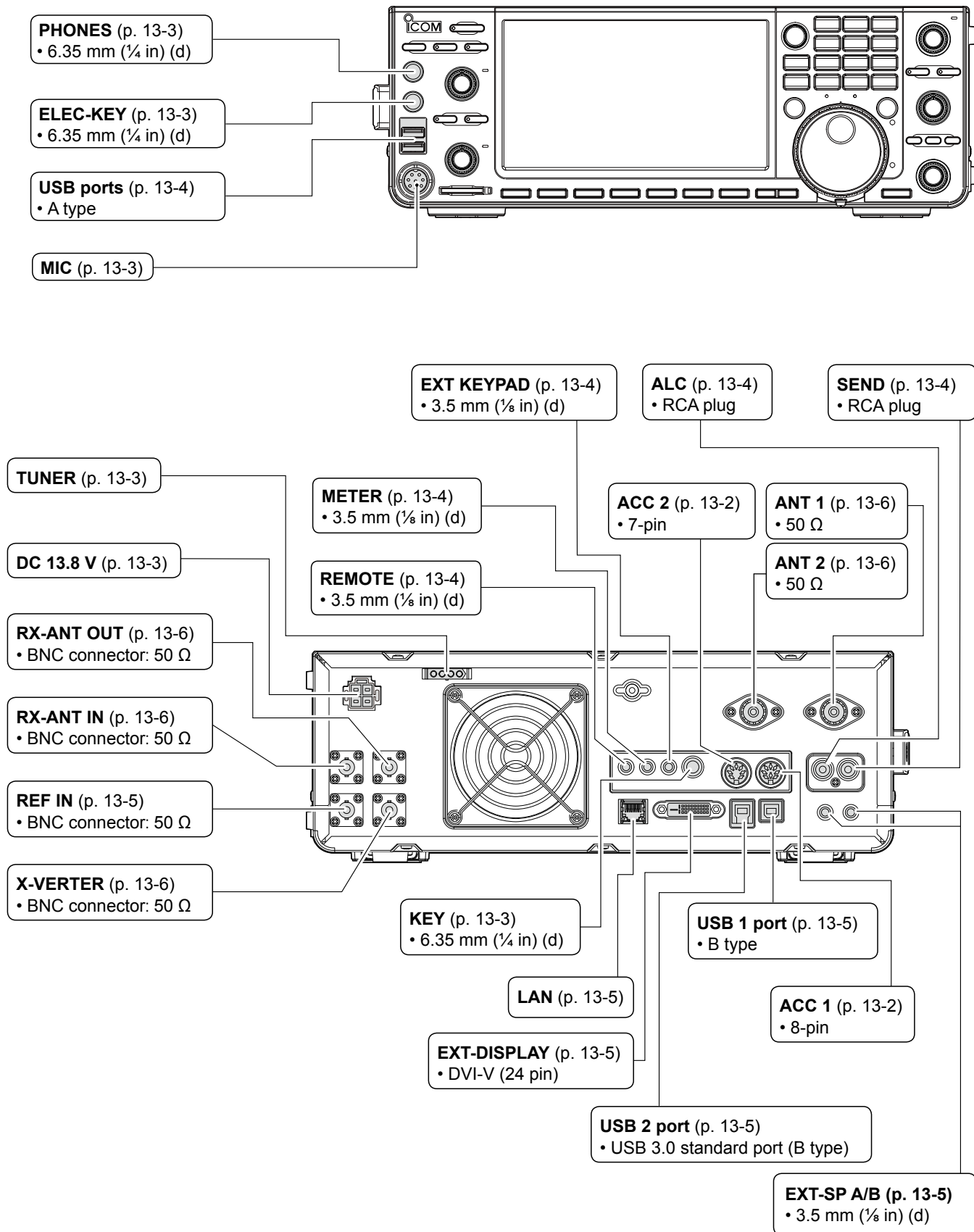

ACC sockets

Connects to external equipment or a PC to control an external unit or the transceiver.

• ACC sockets

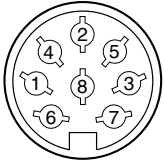
ACC 1	PIN No.	NAME	DESCRIPTION	SPECIFICATIONS	
 <p>8-pin Rear panel view</p>	1	RTTY	Controls RTTY keying.	High level: More than 2.4 V Low level: Less than 0.6 V Output current: Less than 2 mA	
	2	GND	Connects to ground.	Connected in parallel with ACC 2 pin 2.	
	3	SEND* ¹	Input/output pin. Connected in parallel with ACC 2 pin 3.	An external unit controls the transceiver. When this pin goes to ground, the transceiver transmits. The pin goes low when the transceiver transmits.	Input voltage (RX): 2.0 ~ 20.0 V Input voltage (TX): -0.5 ~ +0.8 V Current flow: Maximum 20 mA Output voltage (TX): Less than 0.1 V Current flow: Maximum 200 mA
	4	MOD	Modulator input. Connects to the internal modulator circuit.	Input impedance: 10 kΩ Output level: Approx. 100 mV rms* ²	
	5	AF/IF (IF=12 kHz)* ³	Fixed AF detector or receive IF (12 kHz) signal output.	Output impedance: 4.7 kΩ Output level: 100 ~ 300 mV rms* ⁴	
	6	SQL S	Squelch output. Grounded when the squelch opens.	SQL open: Less than 0.3 V/5 mA SQL closed: More than 6.0 V/100 μA	
	7	13.8 V	13.8 V output when power is ON. Connected in parallel with ACC 2 pin 7.	Output current: Maximum 1A	
	8	ALC	ALC voltage input. Connected in parallel with ACC 2 pin 5.	Input level: -4 ~ 0 V Input impedance: More than 10 kΩ	

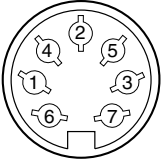
ACC 2	PIN No.	NAME	DESCRIPTION	SPECIFICATIONS
 <p>7-pin Rear panel view</p>	1	8 V	Regulated 8 V output.	Output voltage: 8 V ±0.3 V Output current: Less than 10 mA
	2	GND	Connects to ground (Same as ACC 1 pin 2).	
	3	SEND* ¹	Same as ACC 1 pin 3.	
	4	BAND	Band voltage output. (Varies with the selected amateur band)	Output voltage: 0 ~ 8.0 V
	5	ALC	Same as ACC 1 pin 8.	
	6	TRV	Activates [X-VERTER] input/output when "HIGH" voltage is applied.	Input impedance: More than 10 kΩ Input voltage: 2 ~ 13.8 V
	7	13.8 V	Same as ACC 1 pin 7.	

*¹ When the SEND terminal controls an inductive load, such as a relay, a counter-electromotive force can malfunction or damage the transceiver. To prevent this, we recommend adding a switching diode, such as an 1SS133, on the load side of the circuit to absorb the counter-electromotive force. When the diode is added, a delay in relay switching may occur. Be sure to check its switching action before operating.

(Example) ACC 1/2 socket

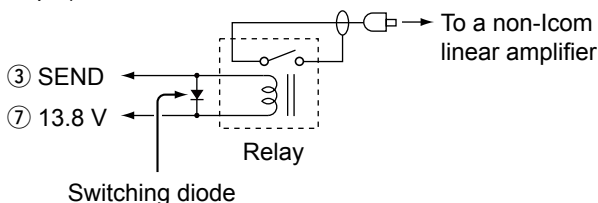

*² You can change the MOD input level.

① 100 mV rms is at 50% as the default.

MENU » SET > Connectors > ACC MOD Level

*³ You can change the AF/IF (IF=12 kHz) settings to output a 12 kHz IF signal. In that case, you can listen to the DRM broadcast with the application software receiver that is installed onto your PC.

MENU » SET > Connectors > ACC Output Select

MENU » SET > Connectors > USB Output Select

MENU » SET > Connectors > LAN Output Select

*⁴ You can change the AF/IF (IF=12 kHz) output level.

① Approximately 200 mV rms is at the 50% as the default.

MENU » SET > Connectors > ACC IF Output Level

MENU » SET > Connectors > USB IF Output Level

PHONES

Connects to standard stereo headphones:

- Output impedance: 8 ~ 16 Ω
- Output level: More than 5 mW into an 8 Ω load.

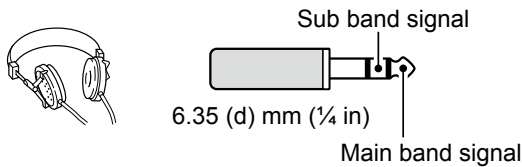

ELEC-KEY

Connects to a CW paddle to activate the internal electronic keyer for CW operation.

① You can select the key type in the following screen.

MENU » SET > KEYER > EDIT/SET > CW-KEY SET > **Key Type**

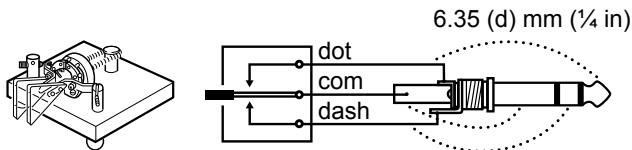

KEY

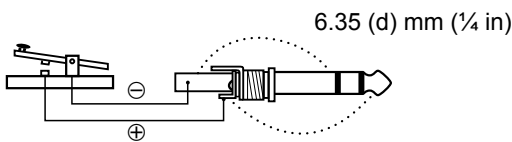

DC 13.8 V

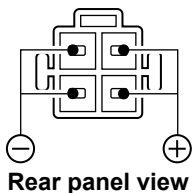

Accepts the regulated DC power for 13.8 V DC ±15% through the supplied DC power cable.

⚠ WARNING! NEVER reverse the DC power cable polarity.

TUNER

Accepts the control cable from an optional AH-4 or AH-740 automatic antenna tuner.

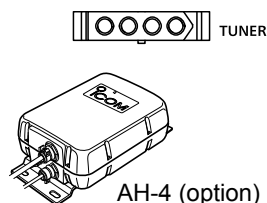

MIC

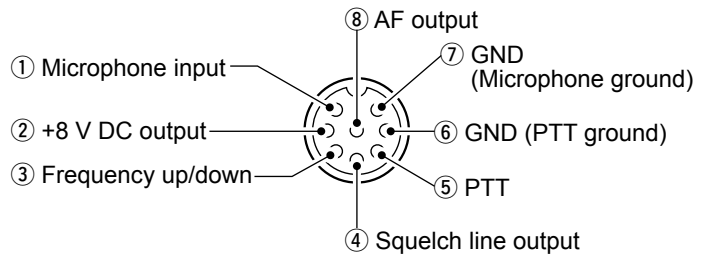

NOTE: Pin 1 outputs 8 V DC power for Icom microphones.

① You can turn OFF the DC power when you use non-Icom microphones in the "MIC Input DC Bias" item on the CONNECTORS screen.

PIN No.	DESCRIPTION
①	Microphone input
②	+8 V DC output (Maximum 10 mA)
③	Frequency up/down
④	Grounded when squelch opens.
⑤	PTT
⑥	PTT ground
⑦	Microphone ground
⑧	AF output (varies with the AF control.)

By connecting an external keypad with a circuit as shown below to [MIC], you can output memory content from 4 memories. You can output memory contents such as that from a CW Memory keyer (M1 ~ M4), Voice memory (T1 ~ T4), RTTY Memory (RT1 ~ RT4), PSK memory (PT1 ~ PT4) to be transmitted.

- Push a switch to send the memory information.
- Hold down the switch for 1 second to repeatedly send the memory information.

① To use the external keypad, turn ON the following items.

MENU » SET > Connectors > **External Keypad**

- VOICE: ON
- RTTY: ON
- KEYER: ON
- PSK: ON

① The External keypad is not supplied by Icom.

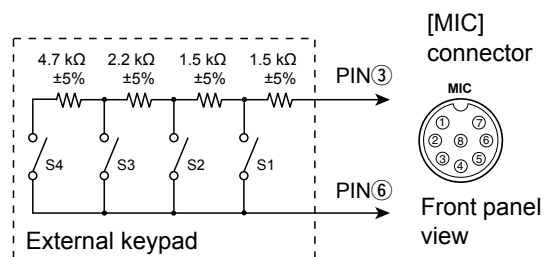

EXT KEYPAD

By connecting an external keypad with a circuit as shown below to [EXT KEYPAD], you can output memory content in 8 channel memories. You can output memory contents such as that from a CW Memory keyer (M1 ~ M8), Voice memory (T1 ~ T8), RTTY Memory (RT1 ~ RT8), PSK memory (PT1 ~ PT8) to be transmitted.

- Push a switch to send the memory information.
- Hold down the switch for 1 second to repeatedly send the memory information.

① To use the external keypad, turn ON the following items.

MENU » SET > Connectors > External Keypad

- VOICE: ON • KEYER: ON
- RTTY: ON • PSK: ON

Mute switch: Mutes both transmission and reception when the switch is turned ON.

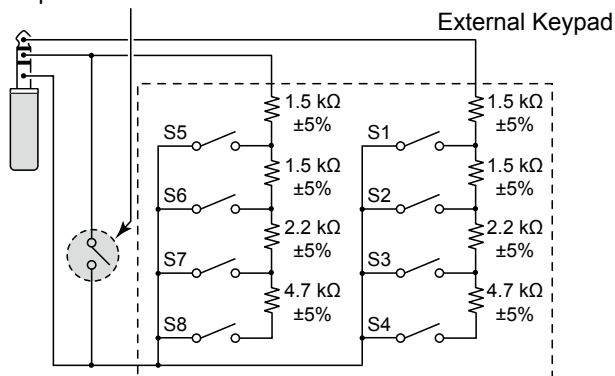

REMOTE

Connects to a PC for remote control using CI-V commands.
3.5 mm (1/8 in) (d)

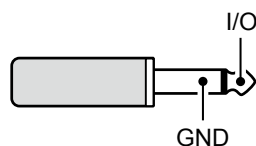

METER

Connects to an external meter.
Outputs the received signal strength or squelch level.
3.5 mm (1/8 in) (d)

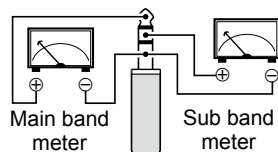

- Output voltage: 8 V (maximum)
- Output impedance: 10 kΩ

① You can select the output signal from received signal strength and squelch levels.

MENU » SET > Connectors

USB port (type A)

Connects a USB A type keyboard, RC-28 REMOTE ENCODER, USB flash drive, mouse or hub.

① Turn OFF the transceiver power when connecting or disconnecting.



NOTE:

- **DO NOT** connect a multimedia adapter, memory card reader, USB HDD, or Bluetooth® keyboard or mouse, as these are not supported by Icom.
- **DO NOT** connect two or more of the same USB devices. (Example: Two USB hubs or two USB mice)

① Connect a PC keyboard for the RTTY and PSK operations.

By connecting a PC keyboard to [USB], you can output memory contents such as that from a CW Memory keyer (M1 ~ M8), Voice memory (T1 ~ T8), RTTY Memory (RT1 ~ RT8), PSK memory (PT1 ~ PT8) to be transmitted.

① To use this function, set the following items to ON.

MENU » SET > Connectors > Keyboard [F1]-[F8] (VOICE)

MENU » SET > Connectors > Keyboard [F1]-[F8] (KEYER)

ALC

Input ALC voltage to the jack when operating with a non-Icom linear amplifier.

• ALC voltage: -4 ~ 0 V

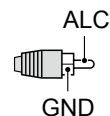

SEND

This terminal is used to control an external equipment such as a non-Icom linear amplifier.

The terminal goes low when the transceiver transmits. (RCA Plug)

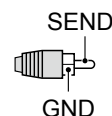

① The T/R switching relay type can be changed on the following screen.

MENU » SET > Connectors > SEND Relay Type

LAN

- Time synchronization by an NTP server.
- Outputs the demodulated signal or 12 kHz IF signal.
- ① You can select the output signal from AF and IF signals.

MENU » SET > Connectors > LAN AF/IF Output

About the LED indication

① LINK/ACT

- Lights when a cable is connected.
- Does not light when a cable is not connected.
- Blinks while communicating.

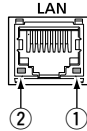

② Speed

- Lights while communicating in 100BASE-TX.
- Does not light while communicating.
- Blinks while communicating in 10BASE-T, or not connected.

EXT-DISPLAY

Connects to an external display monitor.
Outputs the digital RGB signal.

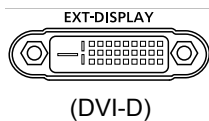

- ① Set the external display settings on the following screen.

MENU » SET > Display > External Display

USB 2

USB (1.1/2.0/3.0) type B
This USB port is for digital data input or output.



- ① The required USB driver and driver's installation guide can be downloaded from Icom web site.

USB 1

USB (1.1/2.0) type B

Connect to the PC when:

- Outputting the decoded FSK (RTTY) data.
- Outputting the demodulated AF signal or 12 kHz IF signal.
- Interface for the remote control by the CI-V command.



- ① You can change the signal output type and output level.

MENU » SET > Connectors > USB Output Select

MENU » SET > Connectors > USB AF Output Level

MENU » SET > Connectors > USB IF Output Level

- ① You can download the USB driver and installation guide from the Icom website.

<http://www.icom.co.jp/world/support/download/firm/index.html>

EXT-SP A / EXT-SP B

Connects to external speakers.
3.5 mm, 1/8 in (d)

- Output impedance: 4 ~ 8 Ω
- Output level: More than 2.0 W at 10% distortion into an 8 Ω load.

① Information

- The internal speaker is deactivated while an external speaker is connected.
- [EXT-SP A] is for the Main band and [EXT-SP B] is for the Sub band.

REF IN

Inputs a 10 MHz signal as a reference frequency signal.

- Input frequency: 10 MHz
- Impedance: 50 Ω (unbalanced)
- Input level: -10 dBm (approximate)

- ① Select the transceiver's reference signal source.

MENU » SET > Connectors > REF IN

- ① Adjust the internal reference frequency.

MENU » SET > Function > REF Adjust

X-VERTER

Outputs HF frequency signals for the Transverter operation.

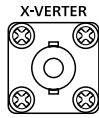

- Input/Output impedance: 50 Ω (unbalanced)
- Output signal level: More than -20 dBm

① Set the “Transverter Function” item to ON to use the transverter operating mode.

MENU » **SET > Function > Transverter Function**

- You cannot select the antenna or use the internal antenna tuner while the Transverter function is ON.

① Set the offset frequency for the transverter operation.

MENU » **SET > Function > Transverter Offset**

ANT 1 / ANT 2

Connect a 50 Ω antenna for the HF to 50 MHz frequency band.

- Input/Output impedance: 50 Ω (unbalanced)

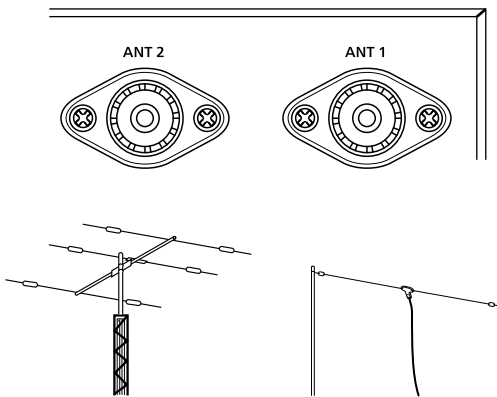

① If you are using the AH-4, connect it to [ANT 1].

RX-ANT IN/OUT

Connect a receive antenna to [RX-ANT IN], and a receiver to [RX-ANT OUT].

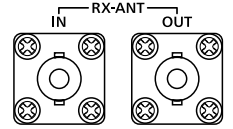

- Input/Output impedance: 50 Ω (unbalanced)
- Connector type: BNC

① Signal is directly received through [RX-ANT IN], instead of the antenna connector.

You can also connect an external preamp or filter, as shown below.

① In this case, set the antenna connector to “ANT 1/R” or “ANT 2/R.” (p. 7-1)

Example

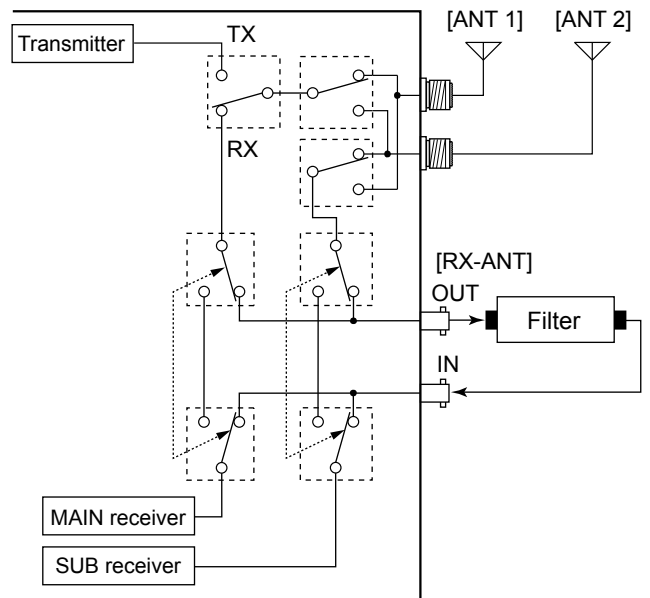

INSTALLATION NOTES

For amateur base station installations it is recommended that the forward clearance in front of the antenna array is calculated relative to the EIRP (Effective Isotropic Radiated Power). The clearance height below the antenna array can be determined in most cases from the RF power at the antenna input terminals.

As different exposure limits have been recommended for different frequencies, a relative table shows a guideline for installation considerations.

Below 30 MHz, the recommended limits are specified in terms of V/m or A/m fields as they are likely to fall within the near-field region. Similarly, the antennas may be physically short in terms of electrical length and that the installation will require some antenna matching device which can create local, high intensity magnetic fields. Analysis of such MF installations is best considered in association with published guidance notes such as the FCC OET Bulletin 65 Edition 97-01 and its annexes relative to amateur transmitter installations. The EC recommended limits are almost identical to the FCC specified 'uncontrolled' limits and tables exist that show pre-calculated safe distances for different antenna types for different frequency bands. Further information can be found at <http://www.arrl.org/>.

• Typical amateur radio installation

Exposure distance assumes that the predominant radiation pattern is forward and that radiation vertically downwards is at unity gain (sidelobe suppression is equal to main lobe gain). This is true of almost every gain antenna today. Exposed persons are assumed to be beneath the antenna array and have a typical height of 1.8 m.

The figures assume the worst case emission of a constant carrier.

For the bands 10 MHz and higher the following power density limits have been recommended:

10–50 MHz 2 W/sq m

Vertical clearance by EIRP output

1 Watts 2.1 m

10 Watts 2.8 m

25 Watts 3.4 m

100 Watts 5 m

1000 Watts 12 m

Forward clearance by EIRP output

100 Watts 2 m

1000 Watts 6.5 m

10,000 Watts 20 m

100,000 Watts 65 m

In all cases any possible risk depends on the transmitter being activated for long periods. (actual recommendation limits are specified as an average during 6 minutes) Normally the transmitter is not active for long periods of time. Some radio licenses will require that a timer circuit automatically cuts the transmitter after 1–2 minutes etc.

Similarly some types of emission, i.e., SSB, CW, AM etc. have a lower 'average' output power and the assessed risk is even lower.

INDEX

	Symbols	
1/4 Tuning function		3-5
A		
ACC sockets		13-2
AF level		4-12
AF level, APF		4-12
AGC		
Function control		4-2
Time constant		4-2
AH-4		2-2, 7-3
AH-740		7-3
Antenna		
Connector setting, Saving		7-1
Memory screen		7-1
Memory settings		7-1
Type		7-2
Antenna tuner		
Connecting		2-2
External, About		7-3
External, Using		7-4
Internal, About		7-2
Internal, Using		7-3
Specifications		11-2
APF (Audio Peak Filter)		4-12
Attenuator		4-1
Audio Peak Filter		4-12
Audio scope		5-2
Auto Tuning		
Function		4-8
Step function		3-5
B		
Band Stacking Register		3-3
Break-in		
Full		4-12
Function		4-11
Semi		4-11
C		
Center frequency, Digital Selector		4-6
Center mode, Spectrum Scope		5-1
CLOCK2		
Displaying		9-1
Name editing		9-2
UTC offset		9-2
Connecting		
External RX Device		7-2
Antenna tuner		2-2
DC power supply		2-1
Linear amplifier		2-3
Non-Icom linear amplifier		2-3
Receive Antenna		7-2
Transverter		2-2
Connector information		13-1
Connectors (Set mode)		8-5
CW-KEY SET		4-13
CW		
Operating		4-10
Pitch control		4-10
Side tone		4-12
D		
Data mode, Selecting		3-3
Date, Setting		9-1
DC power supply, Connecting		2-1
Dial Lock function		3-6
DIGI-SEL		4-6
Digital Selector		4-6
Display		1-4
Display (Set mode)		8-8
Dualwatch		3-2
E		
Editing, keyboard		1-8
Electronic Keyer function		4-13
Emergency mode, Tuner		7-4
Entering		
Example		1-9
Keyboard		1-8
F		
FFT Scope		
Waterfall Display		5-3
Waveform Color		5-3
Waveform Type		5-3
Filter		
IF		4-4
Notch		4-6
Width, Transmit		4-10
Fine Tuning function		3-4
Fixed mode, Spectrum Scope		5-1
Formatting, SD card/USB flash drive		6-2
Frequency		
Entering		3-5
Setting		3-4
Full Break-in mode		4-12
Function (Set mode)		8-2
G		
Grounding		2-1
H		
Heat dissipation		2-1
I		
IC-PW1/IC-PW1EURO		2-3
IF filter		
Selecting		4-4
Shape		4-4
Sharp		4-4
Soft		4-4
Installation, location		2-1
Interface information		13-1
K		
Keyboard		
Entering and editing		1-8
Types		1-8
KEYER 001		4-13
Keyer function, Electronic		4-13
KEYER MEMORY		4-13
Keying speed		4-11
Keypad, Operating band		3-3
L		
Level, Noise Blanker		4-5
Linear amplifier, Connecting		2-3
M		
Main band, Selecting		3-2
Marker, Spectrum Scope		5-1
Memory		
Channel, Entering		3-6
Mode, Selecting		3-1

MENU screen 1-6

Meter

- Display..... 3-7
- Readout..... 3-7

Microphone gain 3-9

Mini scope 5-2

Mode (Memory/VFO), Selecting 3-1

Monitor function 4-7

Multi-function

- Key group 1-7
- Menus..... 1-6
- Meter, About 3-7
- Meter, Displaying 3-8

N

Network (Set mode)..... 8-7

Noise Blanker 4-5

- Depth..... 4-5

Noise Reduction 4-5

Notch

- Auto..... 4-6
- Filter 4-6
- Function type..... 4-6
- Manual 4-7

O

Operating band, Selecting 3-3

Operating mode, Selecting 3-3

Options 12-1

Oscilloscope Waveform Color 5-3

Others (Set mode) 8-10

Output power, Transmit 3-8

P

Panel

- Front 1-1
- Rear 1-3
- Touch screen 1-4

Pitch control, CW 4-10

Position, APF 4-12

Power

- Applying 3-1
- ON or OFF 3-1

Preamplifiers 4-1

Q

QUICK MENU 1-7

Quick Split 4-9

R

Resetting

- All 10-1
- Partial 10-1

RF gain 3-7

RIT

- Function 4-1
- Monitor function 4-1

S

SD card 6-1

- Formatting 6-2
- Inserting 6-1
- Saving data 6-1
- Set mode 8-9
- Unmounting 6-2

Semi Break-in 4-11

Set mode

- Connectors 8-5
- Description 8-1
- Display 8-8
- Function 8-2
- Network 8-7
- Others 8-10
- SD Card 8-9
- Time Set 8-9
- Tone Control/TBW 8-2
- USB Flash Drive 8-10

Side tone, CW 4-12

Specifications 11-1

Spectrum scope 5-1

Speech Compressor (SSB) 4-8

[SPEECH/LOCK] Switch 8-4

Split

- Frequency offset 3-6
- Frequency operation 4-9
- Lock 4-10

SQL 3-7

Squelch

- Noise 3-7
- S-meter 3-7

Sub band, selecting 3-2

T

TBW (Set mode) 8-2

Time Set (Set mode) 8-9

Time, Setting 9-1

Tone Control (Set mode) 8-2

Transmission, Basic 3-9

Transverter, Connecting 2-2

Troubleshooting 10-2

Tuner

- Emergency mode 7-4
- PTT Tuner start 7-3

Tuning

- 1/4 Tuning function 3-5
- Auto 4-8
- Manual 7-3
- Step function, Setting 3-4

Twin PBT, Using 4-3

U

USB flash drive 6-1

- Formatting 6-2
- Inserting 6-1
- Saving data 6-1
- Set mode 8-10
- Unmounting 6-2

UTC offset

- CLOCK2 9-2
- Setting 9-1

V

VFO mode, Selecting 3-1

Volume level, Adjusting 3-1

W

Width

- APF 4-12
- Noise Blanker 4-5

Count on us!

